

Table of Contents

1. Introduction	6
1.1. Minimum System Requirements	7
1.1.1. Windows Users.....	7
1.1.2. Mac Users.....	7
1.2. Supported Formats.....	7
1.3. Box Content	8
1.4. Languages.....	8
1.5. Views of the LaCinema Classic Bridge.....	9
1.5.1. Front View.....	9
1.5.2. Rear View.....	9
1.6. Cables and Connectors.....	10
1.6.1. A/V (Audio/Video) Cables	10
1.6.2. USB Cable.....	10
2. Using the Remote Control.....	11
2.1. Battery Installation.....	11
2.2. Remote Control Key Index.....	12
3. Setting Up the LaCinema Classic Bridge	13
3.1. Step 1: Installing a Hard Drive	13
3.1.1. Option A: Install an Internal Hard Drive.....	14
3.1.2. Option B: Connect an External USB Hard Drive	15
3.2. Step 2: Transfer Files to the Hard Drive.....	16
3.3. Step 3: Connect to the TV.....	17
3.3.1. HDMI (High-Definition) Connection.....	18
3.3.2. Composite & Analog Stereo Audio (Standard Definition) Connection	19
3.3.3. Optical Audio (S/PDIF) Connection	20
4. Playing Multimedia Files.....	21
4.1. Movies Menu.....	22
4.1.1. File information	23
4.1.2. Audio	23
4.1.3. Subtitles	23
4.1.4. Repeat	24
4.1.5. Play mode.....	24
4.1.6. Auto Bookmark	24
4.2. Music Menu	25
4.2.1. Play mode	26
4.2.2. Repeat.....	26
4.2.3. Music Screensaver	26
4.3. Photos Menu	27
4.3.1. Browser Mode.....	28
4.3.2. Play mode	28
4.3.3. Repeat	29
4.3.4. JPEG Duration	29
4.3.5. Transition.....	29
4.4. File Browser Mode	30
4.5. Playback from External Hard Drive.....	30
4.6. Setup Menu	31

4.6.1. Language	31
4.6.2. Video.....	32
4.6.3. Information	32
4.7. Firmware Update	33
5.Reformatting the LaCinema Classic Bridge	34
5.1. Windows Users	34
5.2. Mac Users.....	36
6.Technical Information	37
6.1. XviD Compatibility.....	37
6.2. Optimizing Data Transfers	37
7.Troubleshooting	38
7.1. Troubleshooting: Mac Users.....	38
7.2. Troubleshooting: Windows Users.....	40
7.3. Troubleshooting: TV/Stereo Connection.....	41
8.Contacting Customer Support.....	43
8.1. LaCie Technical Support Contacts	44
9.Warranty Information.....	45
10.Glossary	46

Copyrights

Copyright © 2009 LaCie. All rights reserved. No part of this publication may be reproduced, stored in a retrieval system, or transmitted in any form or by any means, electronic, mechanical, photocopying, recording or otherwise, without the prior written consent of LaCie.

Trademarks

Apple, Mac, and Macintosh are registered trademarks of Apple Inc. Microsoft, Windows 98, Windows 98 SE, Windows 2000, Windows Millennium Edition, Windows XP and Windows Vista are registered trademarks of Microsoft Corporation. Other trademarks mentioned in this manual are the property of their respective owners.

Manufactured under license from Dolby Laboratories. "Dolby" and the double-D symbol are trademarks of Dolby Laboratories.



Changes

The material in this document is for information only and subject to change without notice. While reasonable efforts have been made in the preparation of this document to assure its accuracy, LaCie assumes no liability resulting from errors or omissions in this document, or from the use of the information contained herein. LaCie reserves the right to make changes or revisions in the product design or the product manual without reservation and without obligation to notify any person of such revisions and changes.

Canada Compliance Statement

This Class B digital apparatus meets all requirements of the Canadian Interference-Causing Equipment Regulations.

FCC Statement



This device complies with Part 15 of the FCC Rules. Operation is subject to the following conditions:

1. The devices may not cause harmful interference
2. The devices must accept any interference received, including interference that may cause undesired operation.

NOTE: This equipment has been tested and found to comply with the limits for a Class B digital device, pursuant to Part 15 of the FCC Rules. These limits are designed to provide reasonable protection against harmful interference in a residential installation. This equipment generates, uses and can radiate radio frequency energy and, if not installed and used in accordance with the instructions, may cause harmful interference to radio communications. However, there is no guarantee that interference will not occur in a particular installation. If this equipment does cause harmful interference to radio or television reception, which can be determined by turning the equipment off and on, the user is encouraged to try and correct the interference by one or more of the following measures:

- ◆ Reorient or relocate the receiving antenna.
- ◆ Increase the separation between the equipment and receiver.
- ◆ Connect the equipment into an outlet on a circuit different from that to which the receiver is connected.
- ◆ Consult the dealer or an experienced radio/TV technician for help.

Modifications to this product not authorized by LaCie could void the FCC & Industry Canada regulations and negate your authority to operate the product.

CE Manufacturer's Declaration for CE Certification

We, LaCie, solemnly declare that this product conforms to the following European standards: Class B EN60950, EN55022, EN55024, EN61000-3-2:2000, EN61000-3-3:2001

With reference to the following conditions: 73/23/EEC Low Voltage Directive; 89/336/EEC EMC Directive

CAUTION: Modifications not authorized by the manufacturer may void the user's authority to operate this device.

CAUTION: The LaCinema Classic Bridge's warranty may be void as a result of the failure to respect the precautions listed above.



This symbol on the product or on its packaging indicates that this product must not be disposed of with your other household waste. Instead, it is your responsibility to dispose of your waste equipment by handing it over to a designed collection point for the recycling of waste electrical and electronic equipment. The separate collection and recycling of your waste equipment at the time of disposal will help to conserve natural resources and ensure that it is recycled in a manner that protects human health and the environment. For more information about where you can drop off your waste equipment for recycling, please contact your local city office, your household waste disposal service, or the shop where you purchased the product.

Health and Safety Precautions

- ◆ Only qualified persons are authorized to carry out maintenance on this device.
- ◆ Read this User Manual carefully and follow the correct procedure when setting up the device.
- ◆ Never insert any metallic object into the drive to avoid any risk of electrical shock, fire, short-circuiting or dangerous emissions. If it appears to be malfunctioning, have it inspected by a qualified LaCie Technical Support representative.
- ◆ Never expose your device to rain, or use it near water, or in damp or wet conditions. Never place objects containing liquids on the LaCinema Classic Bridge, as they may spill into its openings. Doing so increases the risk of electrical shock, short-circuiting, fire or personal injury.
- ◆ Make sure that the computer and LaCinema Classic Bridge are electrically grounded. If the devices are not grounded, there is an increased risk

of electrical shock. Power requirements 100-240 V~, 4A, 60-50 Hz, (Supply voltage fluctuations not exceeding $\pm 10\%$ of the nominal, transient over-voltages according to over-voltage category II).

General Use Precautions

- ◆ Do not expose the LaCinema Classic Bridge to temperatures outside the range of 5° C to 30° C (41° F to 86° F); or to operational humidity beyond 5-80%, non-condensing, or non-operating humidity beyond 10-90%, non-condensing. Doing so may damage the LaCinema Classic Bridge or disfigure its casing. Avoid placing your LaCinema Classic Bridge near a source of heat or exposing it to sunlight (even through a window). Inversely, placing your LaCinema Classic Bridge in an environment that is too cold or humid may damage the unit.
- ◆ Always unplug the LaCinema Classic Bridge from the electrical outlet if there is a risk of lightning or if it will be unused for an extended period of time. Otherwise, there is an increased risk of electrical shock, short-circuiting or fire.
- ◆ Use only the power supply shipped with the device.
- ◆ Do not place objects on top of the LaCinema Classic Bridge or use excessive force on it.
- ◆ Never use excessive force on your LaCinema Classic Bridge. If you detect a problem, see the Troubleshooting section in this manual.

CAUTION: A shielded-type power cord is required in order to meet FCC emission limits and also to prevent interference to the nearby radio and television reception. It is essential that only the supplied power cord be used.

Operating Environment Temperatures

- ◆ Do not expose the LaCinema Classic Bridge to temperatures outside the range of 5° C to 30° C (41° F to 86° F). As high end audio/video appliance, the LaCinema Classic Bridge has been designed with an efficient ventilation system. Allow 5 cm of clearance for airflow on all sides of the LaCinema Classic Bridge to prevent overheating. See [Fig. 01](#).
- ◆ Do not stack objects on top of the LaCinema Classic Bridge, as they may interfere with the built-in WiFi antenna. See [Fig. 02](#).

IMPORTANT INFO: Any loss, corruption or destruction of data while using a LaCie drive is the sole responsibility of the user, and under no circumstances will LaCie be held liable for the recovery or restoration of this data. To help prevent the loss of your data, LaCie highly recommends that you keep **TWO** copies of your data; one copy on your external hard disk, for instance, and a second copy either on your internal hard disk, another external hard disk or some other form of removable storage media. LaCie offers a complete line of CD and DVD drives. If you would like more information on backup, please refer to our website.

IMPORTANT INFO: 1GB = 1,000,000,000 bytes. 1TB = 1,000,000,000,000 bytes. Once formatted, the actual available storage capacity varies depending on operating environment (typically 5-10% less).

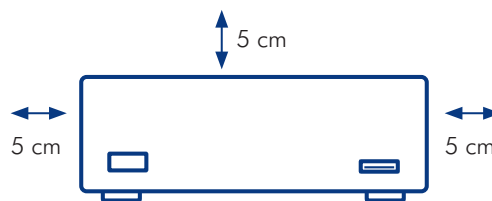

Fig. 01

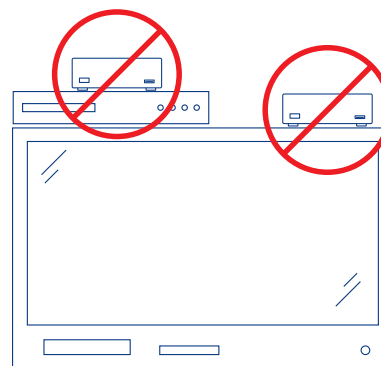

Fig. 02

1. Introduction

Congratulations on the purchase of your new LaCinema Classic Bridge! The LaCinema Classic Bridge plugs directly into a wide array of audio/visual equipment for instant playback of stored home movies, music or photos.

To get started, install either an internal hard drive or plug in an external USB hard drive. Then use your Mac or PC to transfer your movies, music and photos to the LaCinema Classic Bridge. Next, simply connect the LaCinema Classic Bridge to your TV and use the included remote to easily navigate through the menus to listen to music, view photos or watch movies.

Quick Links

Click a topic:

- ◆ [Setting Up the LaCinema Classic Bridge](#)
- ◆ [Using the Remote Control](#)
- ◆ [Playing Multimedia Files](#)



1.1. Minimum System Requirements

1.1.1. Windows Users

- ◆ Windows XP or Windows Vista
- ◆ 500MHz processor or greater
- ◆ 256MB RAM minimum
- ◆ Internet connection (for firmware updates)
- ◆ 3.5" SATA hard drive or external USB hard drive
- ◆ TV systems: PAL, NTSC

1.1.2. Mac Users

- ◆ Mac OS X 10.3 or higher
- ◆ 500MHz processor or greater
- ◆ 256MB RAM minimum
- ◆ Internet connection (for firmware updates)
- ◆ 3.5" SATA hard drive or external USB hard drive
- ◆ TV systems: PAL, NTSC

1.2. Supported Formats

Video	MPEG-4 (DivX, AVI, XviD)
Photo	JPEG
Audio	MP3, WMA, Dolby Digital*
External Subtitles	SUB, SRT, SMI, SSA
Video Outputs	<ul style="list-style-type: none">◆ Composite Video (CVBS)◆ HDMI (up to 1080p)
Audio Outputs	<ul style="list-style-type: none">◆ Stereo Analogue audio (Left and Right)◆ S/PDIF Coaxial audio

*2 channels only. For audio with more than 2 channels, connect the product to a digital home receiver. The audio is passed through the coaxial connection (see section [3.3.3. Optical Audio \(S/PDIF\) Connection](#)).

1.3. Box Content

The package contains the LaCinema Classic Bridge and an accessories box containing the items listed below.

1. LaCinema Classic Bridge
2. Remote control
3. 2 x AAA batteries
4. Video composite + stereo cable
5. HDMI cable
6. USB cable
7. External Power supply
8. Utilities CD-ROM (including LaCie Formatter Utility)
9. Quick Install Guide
10. Case opening tool
11. Screws (x4)

IMPORTANT INFO: Please save your packaging. In the event that the drive should need to be repaired or serviced, it must be returned in its original packaging.

1.4. Languages

Supported Languages

- | | |
|-----------|--------------|
| ❖ English | ❖ French |
| ❖ Italian | ❖ German |
| ❖ Spanish | ❖ Portuguese |

TECHNICAL NOTE: Check the LaCie website for additional languages, which would be made available through a firmware update. www.lacie.com/support

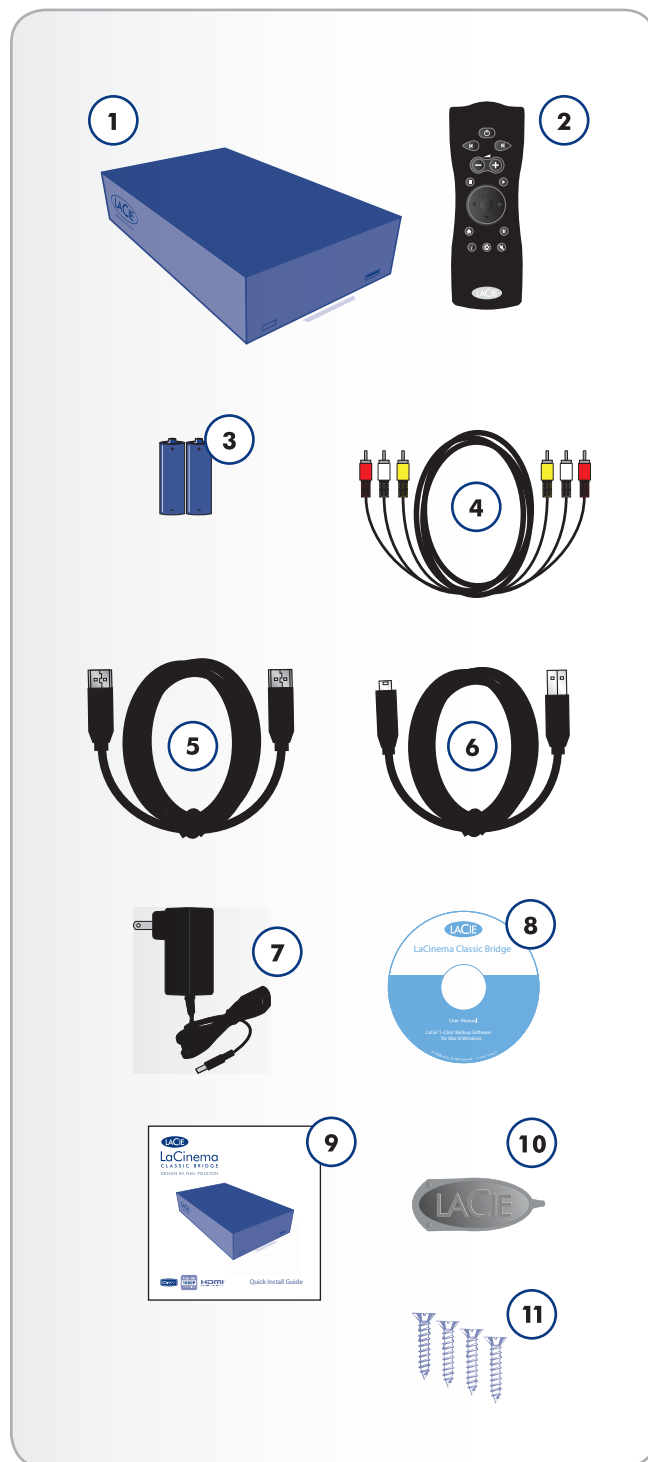

1.5. Views of the Drive

1.5.1. Front View

1. **USB expansion port** – Connect a USB flash disk, hard disk or card reader to access its multimedia files directly from your TV.
2. **Infrared receiver** – Receives the infrared signal from the remote control. Make sure the receiver is not obstructed.

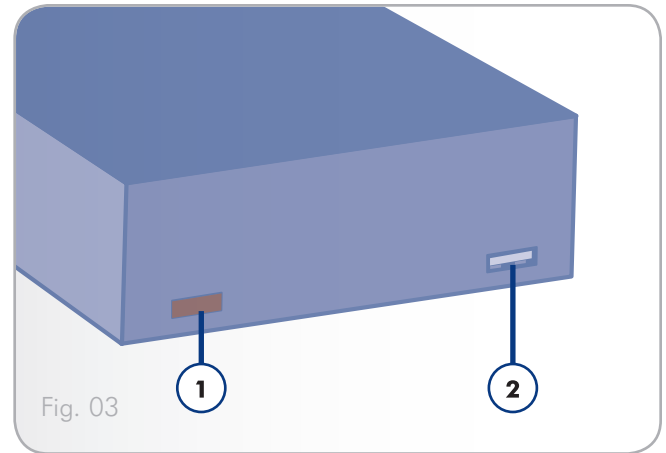

1.5.2. Rear View

1. Power supply connector
2. USB port (to connect to a PC)
3. HDMI connector
4. Video composite + stereo connector
5. Coaxial digital audio connector

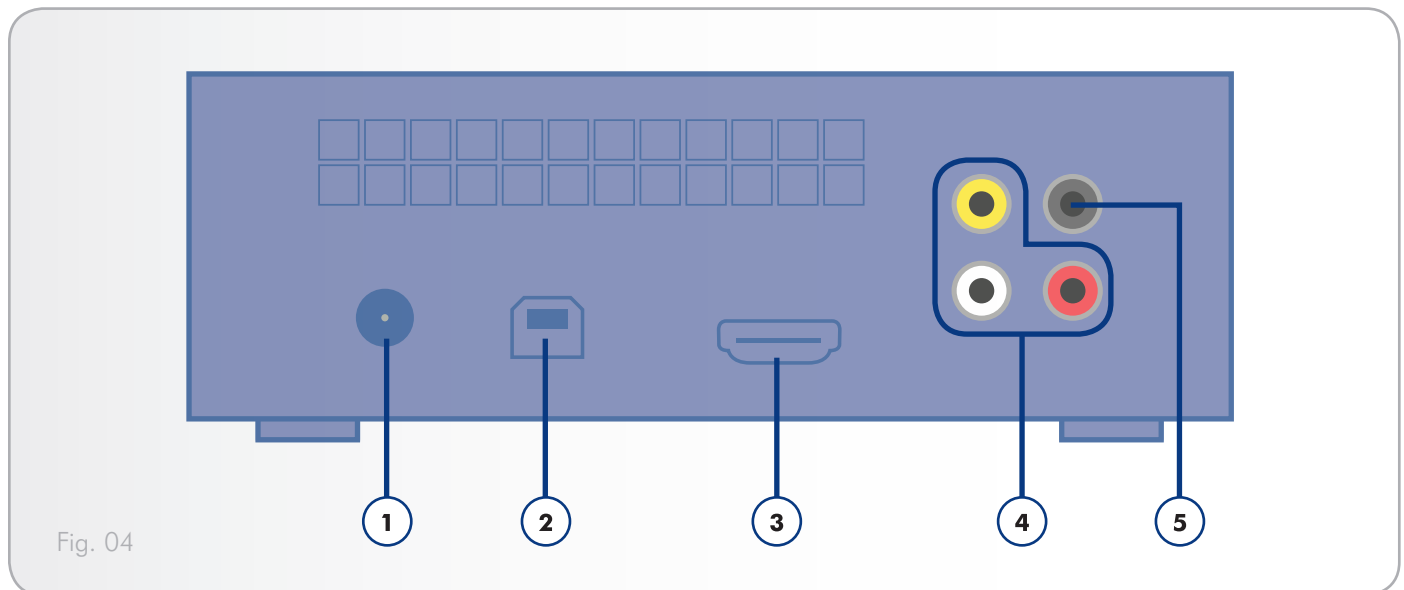

1.6. Cables and Connectors

1.6.1. A/V (Audio/Video) Cables

The A/V cables provide the audio and video signals to your stereo and TV. The LaCinema Classic Bridge supports the A/V standards shown below:

1. **Composite video/stereo audio (Fig. 05)** – This is the most standard video connection (yellow) as well as left (white) and right (red) stereo audio inputs. If your TV only has a SCART connector, you can purchase an adapter from your local retailer that will allow you to connect the composite video/stereo audio plugs to the SCART connection.
2. **HDMI (High-Definition Multimedia Interface (Fig. 06))** – This is the best audio/video method for connecting the LaCinema Classic Bridge to HDTVs.

1.6.2. USB Cable

USB is a serial input/output technology for connecting peripheral devices to a computer or to each other. Hi-Speed USB 2.0 is the latest implementation of this standard, and it provides the necessary bandwidth and data transfer rates to support high speed devices such as hard drives, CD/DVD drives and digital cameras.

Included USB Cable

Your LaCinema Classic Bridge is shipped with a Hi-Speed USB 2.0 cable (Fig. 07), to ensure maximum data transfer performance when connected to a Hi-Speed USB 2.0 port. The cable will also work when connected to a USB port, but drive performance will be limited to USB 1.1 transfer rates.

Hi-Speed USB 2.0 Benefits

- ◆ Backwards compatibility: Hi-Speed USB 2.0 works with the original USB specifications.
- ◆ Hot-pluggable: no need to shut down or restart your computer when adding or removing devices.

TECHNICAL NOTE: To achieve Hi-Speed USB 2.0 data transfer rates you need to be connected to a Hi-Speed USB 2.0 host interface. Otherwise, transfer rates will be limited to USB 1.1 speeds.

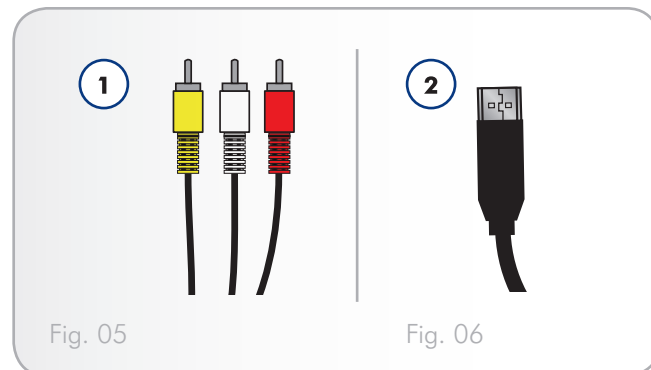

2. Using the Remote Control

Some of the buttons of the remote control have different functions or no function at all depending on the type of file you are viewing. This chapter discusses the button functions for each type of file (movies, photos and music) and battery installation.

2.1. Battery Installation

The remote control uses two AAA batteries. The batteries are not pre-installed, so you will need to install them before you can use the remote control.

To install the batteries:

1. Remove the battery compartment cover.
2. Load the batteries onto the battery compartment. Position the batteries so that the “+” symbols on the batteries face the same direction as the “+” symbols on the battery compartment.
3. Slide the battery compartment cover back into the remote.

IMPORTANT INFO: If you will not be using the remote control for an extended period of time, LaCie recommends that you remove the batteries.

IMPORTANT NOTE: Make sure there is a clear path between the remote control and the LaCinema Classic Bridge.



2.2. Remote Control Key Index

The LaCinema Classic Bridge's remote control allows you to control the LaCinema Classic Bridge while its connected to your TV or home theatre center.

Button	Function
1. Power	Power on/off
2. Next	Skip to next track
3. Previous	Back to previous track
4. Volume down	Adjust volume down
5. Volume up	Adjust volume up
6. Stop	Stop the current file playback
7. Play / Select	Play selected file / confirm selection
8. Direction	<ul style="list-style-type: none"> ◆ Right and left buttons: navigate in the menu ◆ Up and down buttons: scroll in the list
9. Home / Now playing	Back to main menu / go to "now playing" music track
10. Info / contextual menu	Display info and on screen menu
11. Pause	Pause playback
12. Mute	Turn off sound output
13. Setup	Enter main set up menu

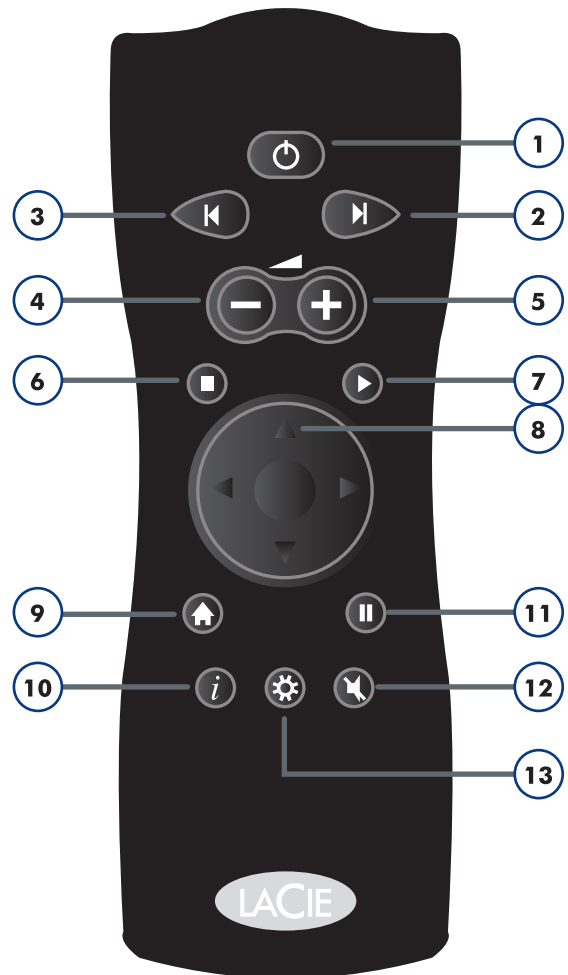

3. Setting Up the LaCinema Classic Bridge

Setup consists of four steps:

- ◆ *Step 1: Installing a Hard Drive*
- ◆ *Step 2: Transfer Files to the Hard Drive*
- ◆ *Step 3: Connect to the TV*

Once setup is complete and the drive is connected to your TV, proceed to section [4. Playing Multimedia Files](#).

3.1. Step 1: Installing a Hard Drive

You must install a hard drive, where you will store your files. You have two choices:

- ◆ *3.1.1. Option A: Connect an External USB Hard Drive*

OR

- ◆ *3.1.2. Option B: Install an Internal Hard Drive*
-

3.1.1. Option A: Connect an External USB Hard Drive

IMPORTANT NOTE: The LaCinema Classic Bridge is compatible only with disks formatted in FAT32. If you attempt to install a disk formatted in NTFS or HFS+, files will not be available when the drive is connected to the television. Refer to section 5. *Reformatting the LaCinema Classic Bridge* for formatting information.

The FAT32 file system is compatible with almost all computers but file size is limited to 4GB and partition size of more than 32GB is not properly supported. Windows users should use the Formatter Utility included on the CD-ROM, which will allow them to format their drive in one large FAT32 partition.

1. Connect your USB hard drive's power cord (if applicable) and turn it on (if applicable).
2. Connect the USB cable from the USB hard drive to the USB port on the front of the LaCinema Classic Bridge (Fig. 08).

Proceed to section 3.2. *Step 2: Transfer Files to the Hard Drive.*

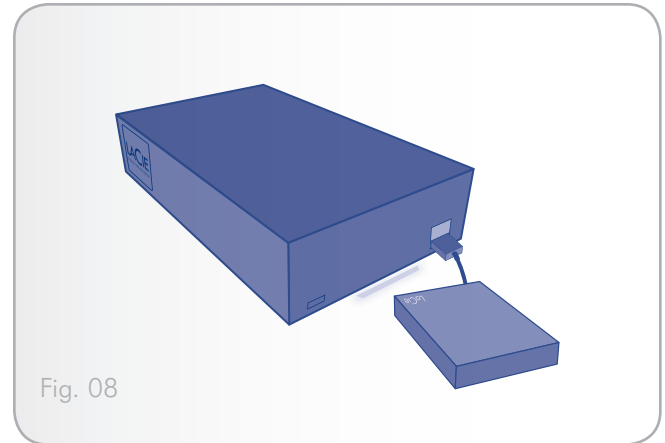

Fig. 08

3.1.2. Option B: Install an Internal Hard Drive

IMPORTANT NOTE: The LaCinema Classic Bridge is compatible only with disks formatted in FAT32. If you attempt to install a disk formatted in NTFS or HFS+, files will not be available when the drive is connected to the television. Refer to section 5. *Reformatting the LaCinema Classic Bridge* for formatting information.

The FAT32 file system is compatible with almost all computers but file size is limited to 4GB and partition size of more than 32GB is not properly supported. Windows users should use the Formatter Utility included on the CD-ROM, which will allow them to format their drive in one large FAT32 partition.

IMPORTANT NOTE: Install only a 3.5" SATA hard disk. Disks with 5400 RPM are strongly recommended. Check lacie.com for a list of compatible drives. LaCie cannot guarantee that drives not on this list will be compatible with the LaCinema Classic Bridge.

Drive Installation

CAUTION: If you are replacing a drive, make sure that it has cooled before touching it.

1. Make sure the power cable is disconnected.
2. Turn the drive over so the rubber feet are pointing up.
3. Opening the casing by wedging the included Case Opening Tool into the seam between the bottom plate and the top shell and gently pry them apart (Fig. 09).
4. Turn the drive over and remove the top shell.
5. Slide the drive, label facing up, onto the bottom plate until the SATA connector plugs into the LaCinema Classic Bridge's internal SATA port (Fig. 10).
6. Secure the disk drive in the casing by inserting the four screws (included) as indicated (Fig. 11).
7. Replace the casing by first aligning the video ports on the bottom plate with the cutouts on the top shell and then pressing down until it clicks (Fig. 12).

Proceed to section 3.2. *Step 2: Transfer Files to the Hard Drive.*

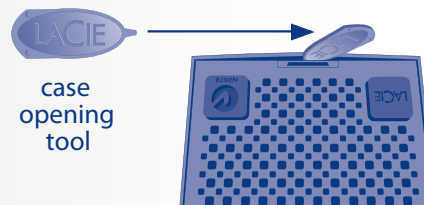

Fig. 09

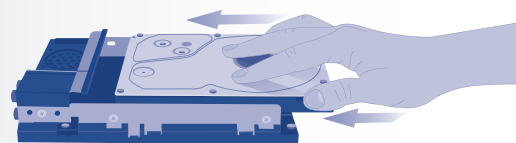

Fig. 10

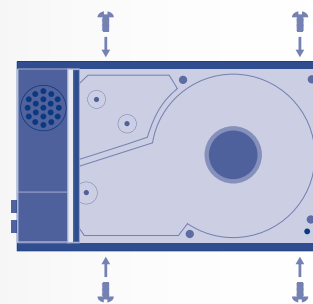

Fig. 11



Fig. 12

3.2. Step 2: Transfer Files to the Hard Drive

1. Make sure that you have either connected an external USB hard drive or installed an internal hard drive as outlined in section 3.1. [Step 1: Installing a Hard Drive](#).
2. Connect the power supply which powers on the LaCinema Classic Bridge.
3. Connect the USB cable from the LaCinema Classic Bridge to your computer.
 - ◆ See [Fig. 13](#) if you installed an internal hard drive.
 - ◆ See [Fig. 14](#) if you connected an external USB hard drive.
4. Access the drive in [My Computer](#) (Windows users) or from the [Desktop](#) (Mac users). Create folders on the mounted volume in which to place your media (MOVIES, MUSIC, PICTURES, and UPDATE) (see [Fig. 15](#)). The names must be exact.

IMPORTANT INFO: You must correctly categorize your files (i.e., music in the Music folder) or they will not be properly classified on your TV.

TECHNICAL NOTE: Windows users only: If you use the [Formatter Utility](#) (located on the CD-ROM) to reformat your external hard drive to FAT32, it will create the folders for you.

5. Copy your multimedia files by adding your music, photos, and videos by simply dragging and dropping to the appropriate folders.
6. Unmount the volume and disconnect the USB cable from your computer.

TECHNICAL NOTE: It is also possible to transfer files to an external hard drive before connecting it to the LaCinema Classic Bridge (see [Fig. 16](#)).

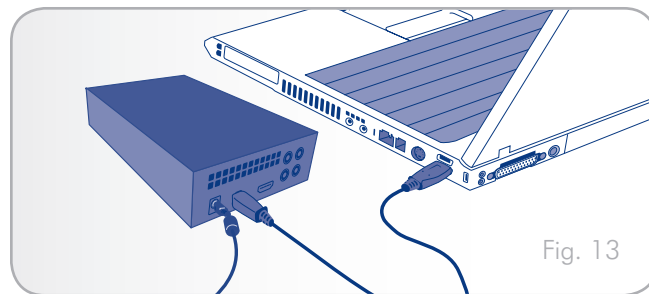

Fig. 13

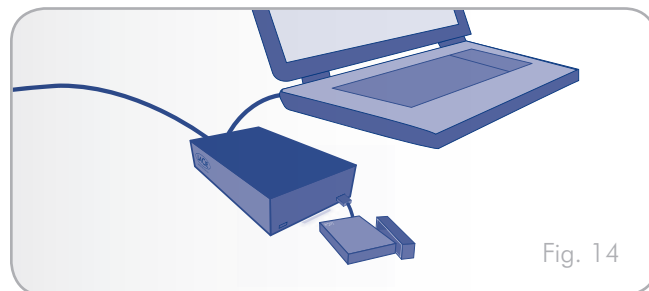

Fig. 14

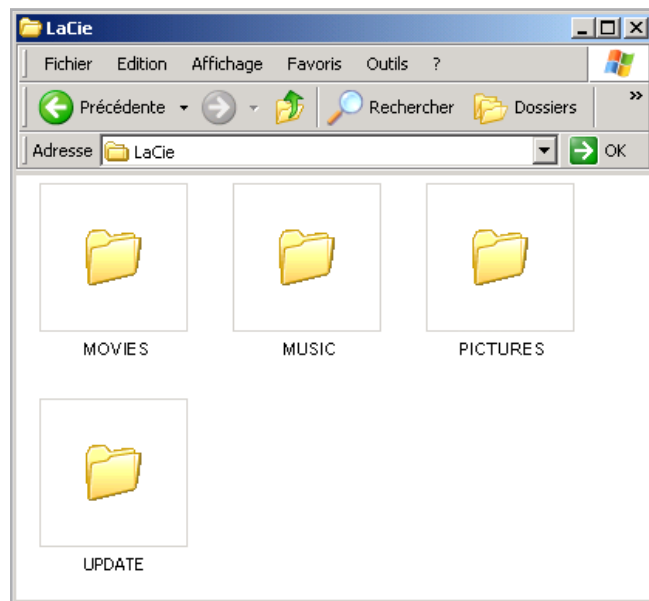

Fig. 15

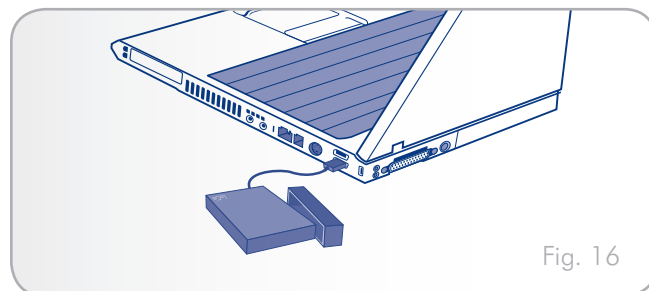

Fig. 16

3.3. Step 3: Connect to the TV

The LaCinema Classic Bridge supports different ways of connecting to televisions. From these methods, choose the setup that matches the ports on your television or receiver:

- ◆ [3.3.1. HDMI \(High-Definition\) Connection](#)
- ◆ [3.3.2. Composite & Analog Stereo Audio \(Standard Definition\) Connection](#)

In each of the above connection methods, it is possible to connect the LaCinema Classic Bridge to home theater systems by plugging the S/PDIF cable (not included) to your digital amplifier via the digital optical audio connector (see section [3.3.3. Optical Audio \(S/PDIF\) Connection](#) for details).

The chart at right illustrates the qualities made possible by the different connection methods.

TECHNICAL NOTE: The connectors on the rear of your TV may not appear exactly the same as shown below. Please read the labels next to the connectors carefully to ensure correct connections.

IMPORTANT INFO: The LaCinema Classic Bridge cannot be connected to a TV and computer at the same time.

[continued on the next page >>](#)

Definition	Connection	Maximum Resolution
High Definition	HDMI	1080p
Standard Definition	Composite	576p

3.3.1. HDMI (High-Definition) Connection

IMPORTANT INFO: Before connecting the cable, power off your TV.

1. Connect the LaCinema Classic Bridge's power cord.
2. Connect one end of the HDMI cable to your television's HDMI port ([Fig. 18](#)).
3. Connect the other end to the HDMI port on the back of the LaCinema Classic Bridge.
4. Once connected, press the **Gear** button  and select the Video menu in order to adjust, if necessary, the video output resolution of the product to match your TV's resolution from 720p to 1080p.

Move on to the next step, [4. Playing Multimedia Files](#).

TECHNICAL NOTE: If your TV's HDMI port is being used by another device, or if your TV doesn't have an HDMI port, you can connect to the TV using the Composite connection (see section [3.3.2](#) for details).

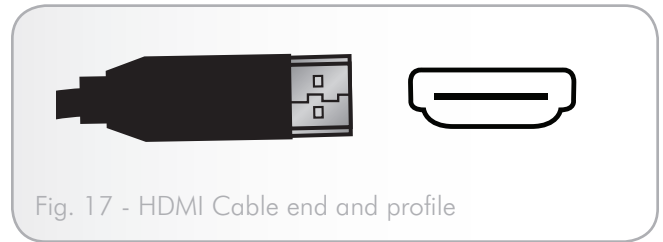

Fig. 17 - HDMI Cable end and profile

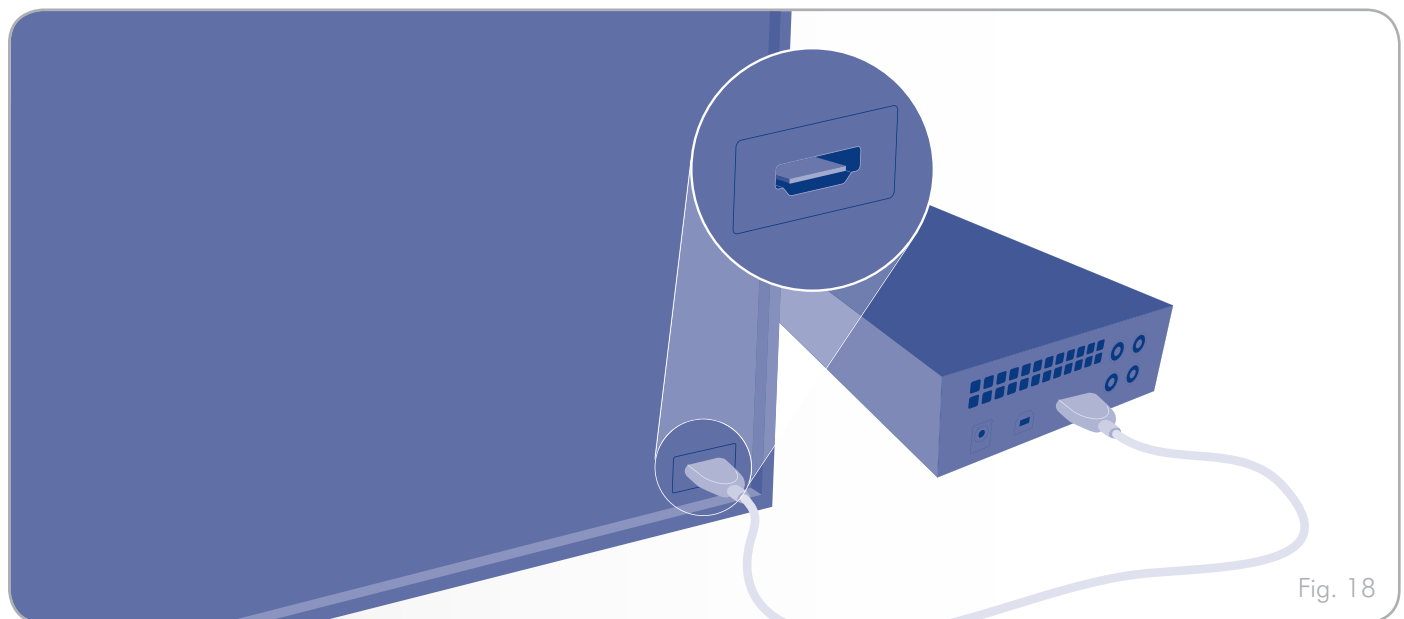

Fig. 18

3.3.2. Composite & Analog Stereo Audio (Standard Definition) Connection

IMPORTANT INFO: Before connecting the cables, power off your TV.

1. Connect the LaCinema Classic Bridge's power cord.
2. Connect the yellow connector on one end of a analogue composite/stereo cable to the CVBS port on your TV ([Fig. 20](#)).
3. Connect the yellow connector on the other end of the composite/stereo cable to the LaCinema Classic Bridge
4. Connect the analog audio parts of the cable (red and white connectors), to your TV and to the LaCinema Classic Bridge.

Move on to the next step, [4. Playing Multimedia Files](#).

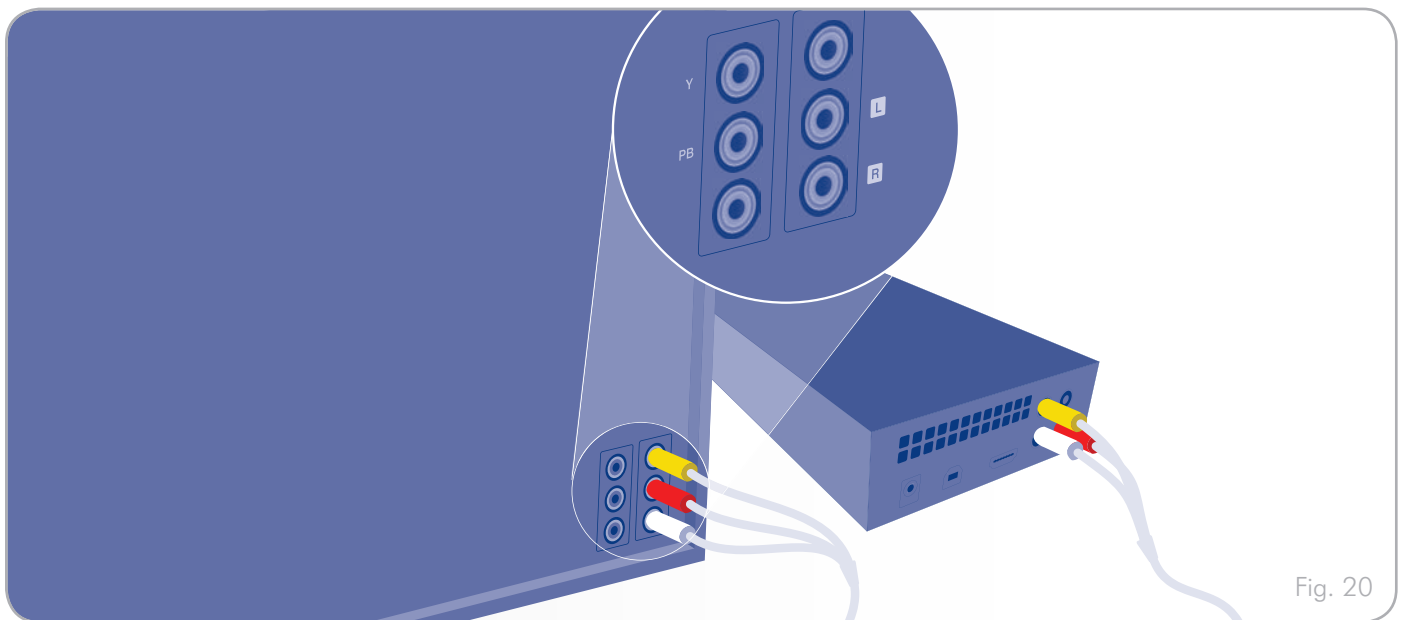
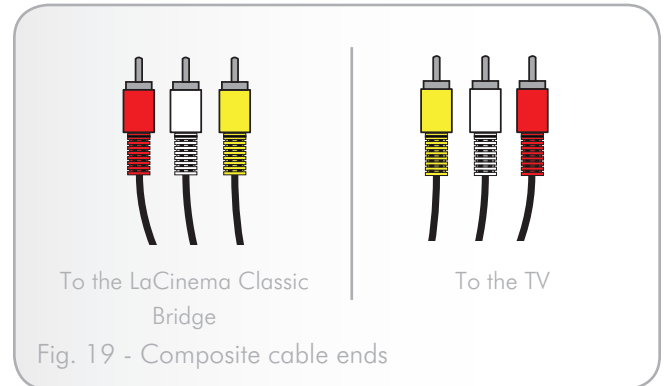

3.3.3. Optical Audio (S/PDIF) Connection

IMPORTANT INFO: Before connecting the cable, power off your digital amplifier.

In the Composite or HDMI connection methods, it is possible to connect the LaCinema Classic Bridge to home theater systems by plugging the S/PDIF cable (not included) into your digital amplifier via the LaCinema Classic Bridge's digital optical audio connector. For the Composite connection, connect EITHER the S/PDIF cable or the stereo audio cable (with red and white tips).

1. Connect one end of a S/PDIF cable to your digital amplifier (Fig. 22).
2. Connect the other end of the cable to the back of the LaCinema Classic Bridge.

Move on to the next step, [4. Playing Multimedia Files](#).

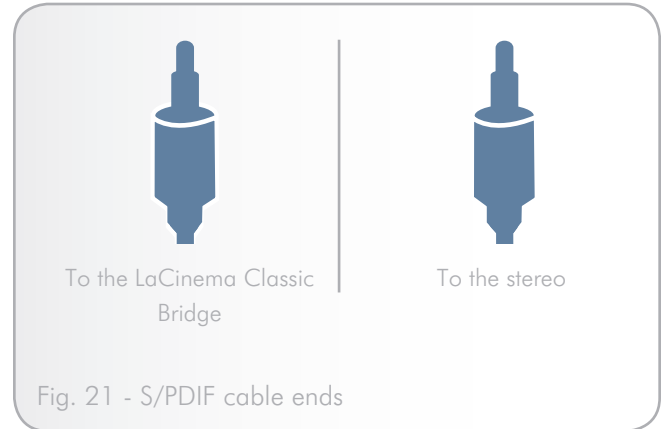

Fig. 21 - S/PDIF cable ends

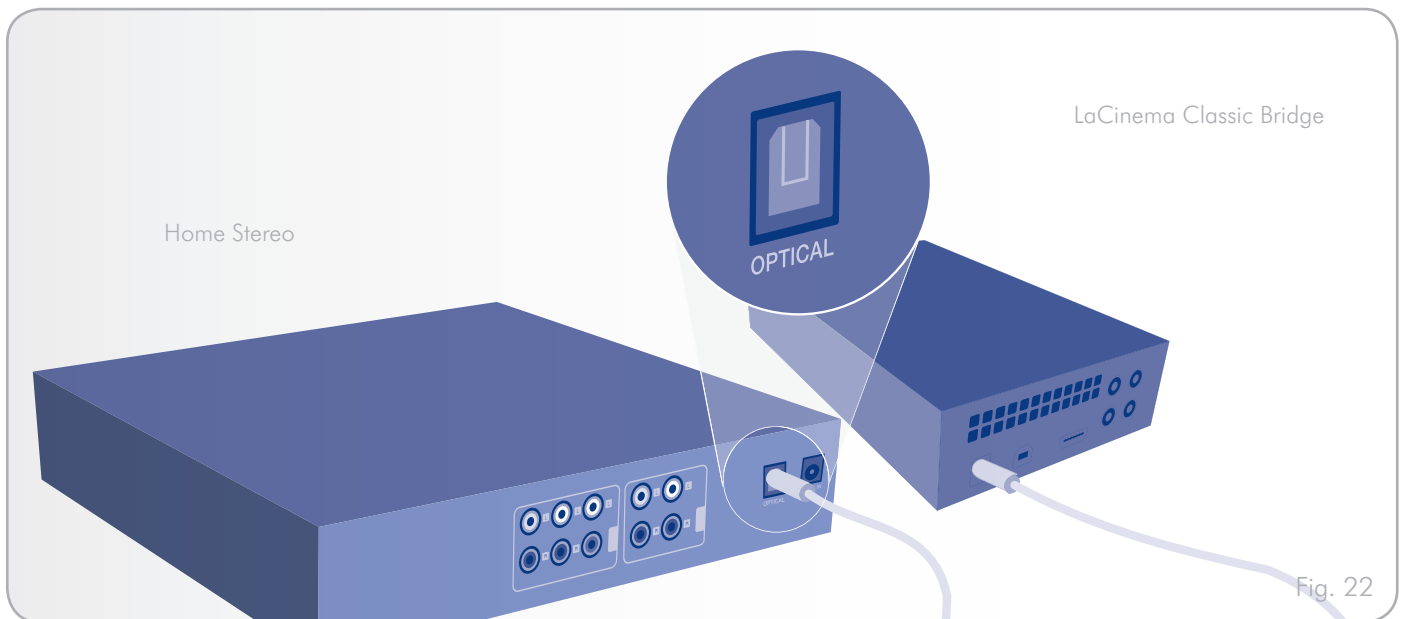

Fig. 22

4. Playing Multimedia Files

IMPORTANT NOTE: You must turn on the LaCinema Classic Bridge by pressing the remote control power button.

The following sections provide an overview of the different menu options of the LaCinema Classic Bridge while it is connected to your TV.

When you first power on the LaCinema Classic Bridge, the [Main Menu](#) appears. From this menu, you can choose from four different media:

- ◆ Movies
- ◆ Music
- ◆ Photos
- ◆ All Media

TECHNICAL NOTE: The LaCinema will perform a hard disk scan. The duration of the scan will depend on the number of files on the disk.

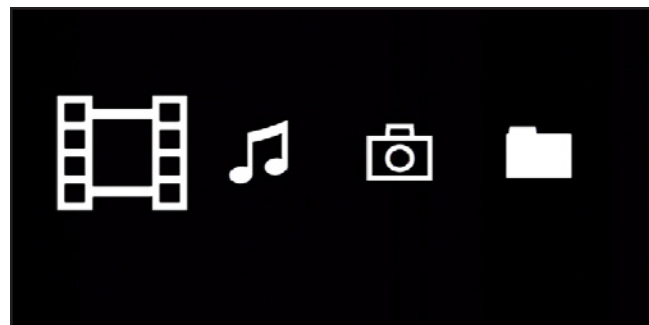

Fig. 23

4.1. Movies Menu

You can scroll through the menus using the navigation buttons. To confirm your choice and enter a menu, press the **Play** button (Fig. 24).

This menu will display all of the video files that you have uploaded to the MOVIES folder on your LaCinema Classic Bridge.

Only files recognized as movie files will be displayed. Music and photo files will not be displayed. To view all file types, select the **Browser** menu.

You can scroll through the list of movie files and folders using the **Up** and **Down** buttons, **Right** button to open a folder and **Left** to move to upper folder level (Fig. 25).

To confirm your choice, press the **Play** button.

A loading animation will appear while the movie is being analyzed to ensure optimum playback experience.

TECHNICAL NOTE: Movie loading can take up to 30 seconds depending on file length and encoding parameters.

TECHNICAL NOTE: If the movie cannot be played, the following message will be displayed: "Cannot play the movie". Press the **Stop** button or wait 5 seconds to go back to the browser menu.

During the file playback, you can retrieve movie information and adjust several playback parameters. Press the **i** button to display or exit the on-screen menu (Fig. 26).

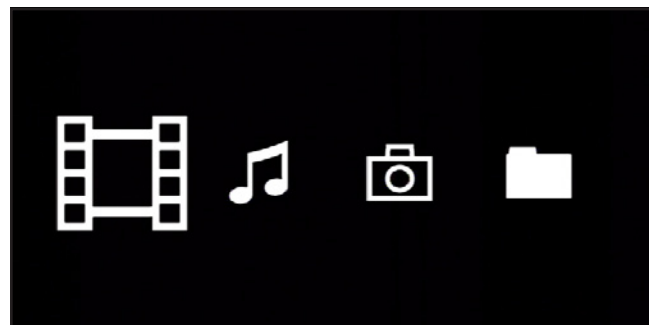

Fig. 24

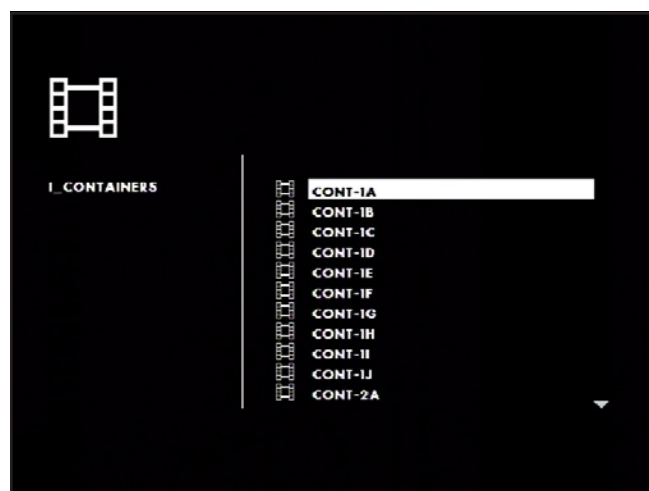

Fig. 25

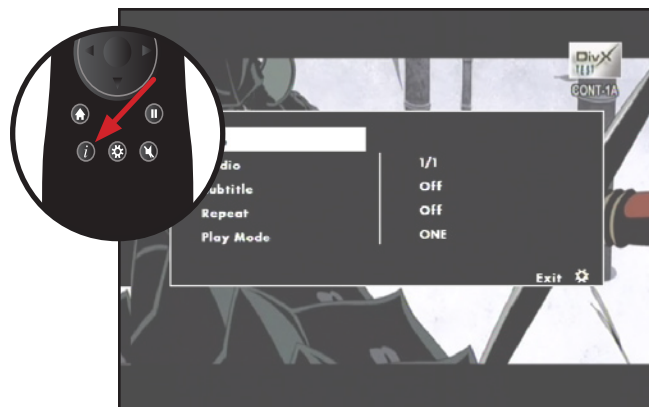

Fig. 26

4.1.1. File information

The information screen gives you main movie and playback information.

4.1.2. Audio

Lists audio track(s) embedded in the currently playing movie (Fig. 27).

4.1.3. Subtitles

Lists subtitle status and list of embedded subtitles (Fig. 28).

Subtitle Compatibility

In order for the LaCinema Classic Bridge to display subtitles in the MPEG-4 format, both the “movie.avi” and the “movie.srt” files should be placed in the same directory. Make sure that only one subtitle with the same file name is in the movie’s folder. The external subtitle will be loaded even if the movie file contains an embedded subtitle. To play the embedded subtitle, remove the external subtitle file and push the **i** button to select the embedded subtitle.

IMPORTANT INFO: The LaCinema Classic Bridge is not designed, intended or may be used to violate any one’s copyright or other IP (Intellectual Property) rights. Each LaCinema Classic Bridge user may only use their LaCinema Classic Bridge in conjunction with materials legally owned or licensed by such user, and only to the extent that such ownership or license rights permit such use.

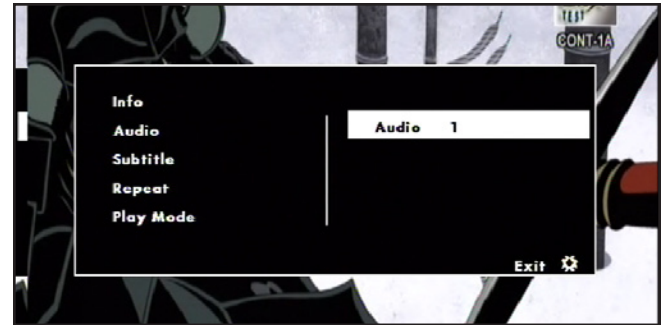

Fig. 27

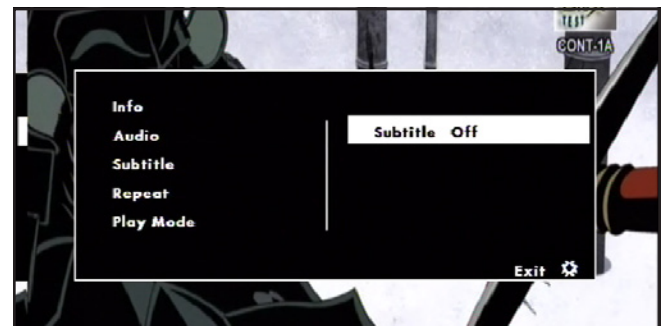

Fig. 28

4.1.4. Repeat

Sets the movie repeat mode status. Select **On** to repeat the same movie continuously – **Off** to stop playback at the end the movie (Fig. 29).

4.1.5. Play mode

Applies to all movies located in the same folder. Select **Play one** to return to the Movies menu list at the completion of a movie, or **Play all** to begin the next movie at the conclusion of a movie (Fig. 30).

4.1.6. Auto Bookmark

If a movie has been stopped before its end and is played back again later on, a message will ask whether to resume from the last stop position or to start from the beginning. The last five movies will be kept in memory for future playback resumption (Fig. 31).

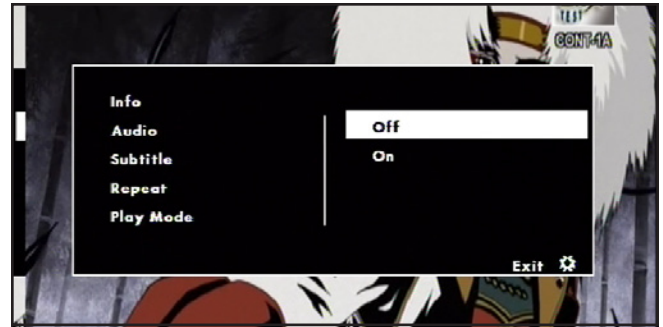

Fig. 29

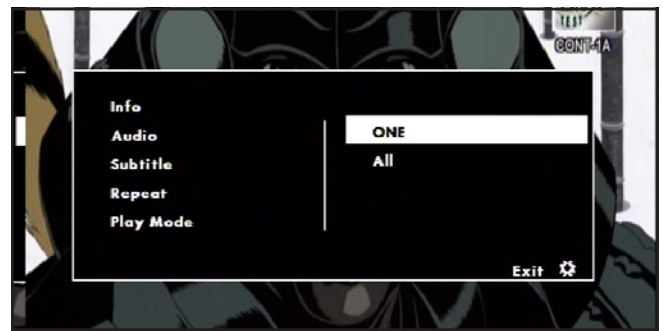

Fig. 30

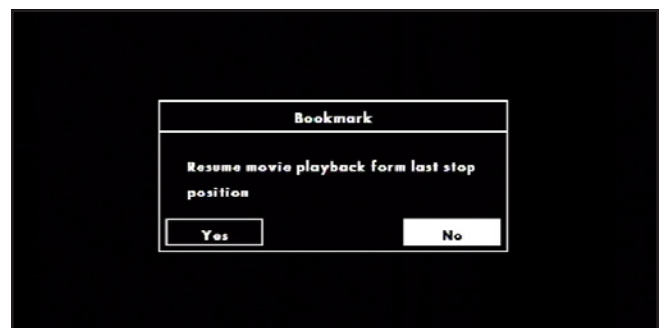

Fig. 31

4.2. Music Menu

You can scroll through the menu using the navigation buttons. To confirm your choice and enter a menu, press the **Play** button (Fig. 32).

This menu will display all of the audio files that you have uploaded to your LaCinema Classic Bridge. Only files recognized as music files will be displayed. Movies and photo files will not be displayed. To view all file types, select the **Browser** menu.

You can scroll through the list of music tracks and folders using the **Up** and **Down** buttons, **Right** button to open a folder and **Left** to move to upper folder level. To confirm your choice, press the **Play** button (Fig. 33).

During the file playback, you can adjust several playback parameters. Press the **i** button to display or exit the on-screen menu (Fig. 34).

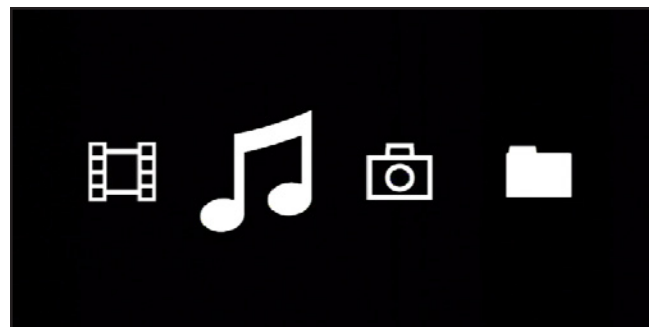

Fig. 32



Fig. 33

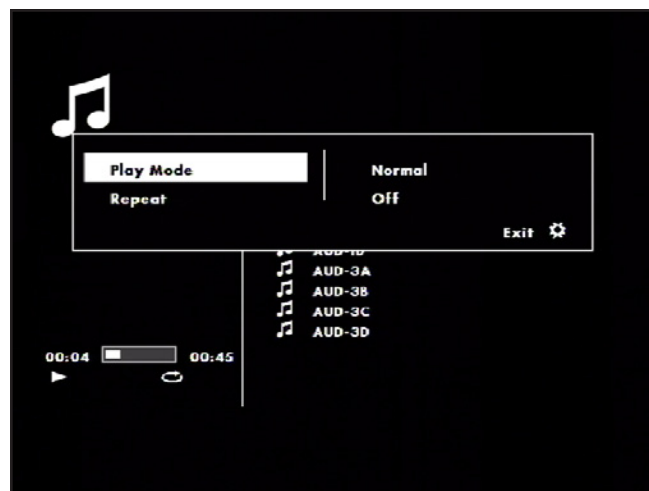

Fig. 34

4.2.1. Play mode

Select [Shuffle](#) to play songs in random order or [Standard](#) to play songs in continuous order ([Fig. 35](#)).

4.2.2. Repeat

Set the repeat audio status. Select [ON](#) to repeat the songs in the folder continuously, and [Off](#) to stop playback at the end when all song in the folder have been played ([Fig. 36](#)).

4.2.3. Music Screensaver

After one minute of music playback, a screensaver will appear. Press the [Play](#) button to display the Music menu.

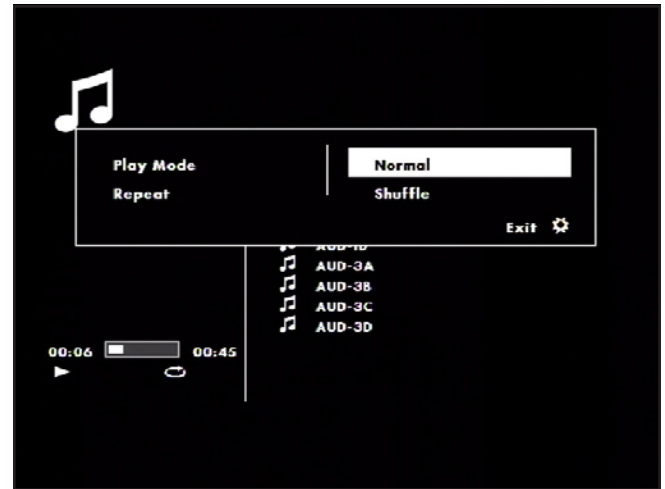

Fig. 35

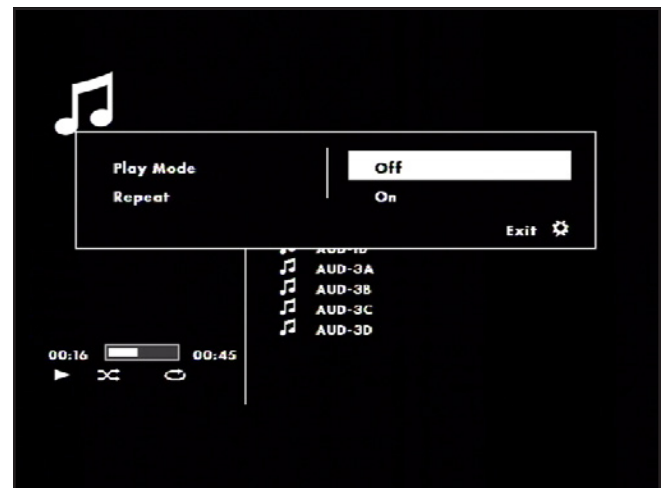

Fig. 36

4.3. Photos Menu

You can scroll through the menu using the navigation buttons. To confirm your choice and enter a menu, press the **Play** button (Fig. 37).

This menu will display all of the image files that you have uploaded to your LaCinema Classic Bridge. Only files recognized as image files will be displayed. Movies and music files will not be displayed. To view all file types, select the **Browser** menu.

You can scroll through the list of photos and folders using the **Up** and **Down** buttons, **Right** button to open a folder and **Left** to move to upper folder level. To confirm your choice, press the **Play** button (Fig. 38).

During the file playback, you can adjust several playback parameters. Press the **i** button to display or exit the on-screen menu (Fig. 39).

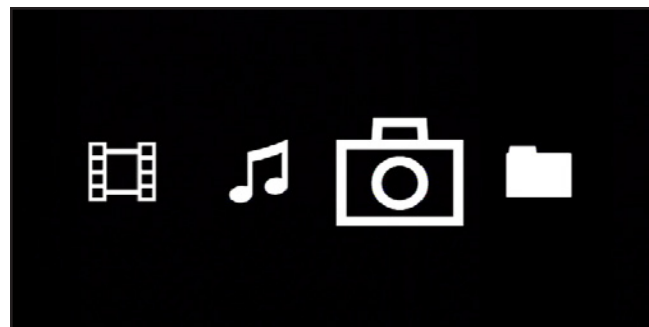

Fig. 37



Fig. 38

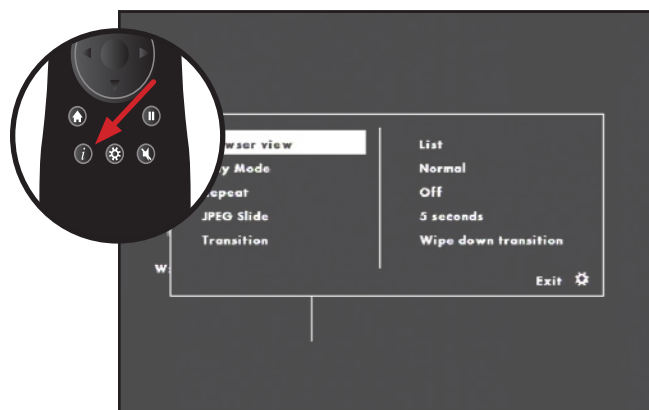

Fig. 39

4.3.1. Browser Mode

This function allows you to see a thumbnail of photos as you scroll through the photo menu. Select either [List](#) mode (to see only the file name) or [Thumbnail](#) mode ([Fig. 40](#)).

4.3.2. Play mode

Select [Shuffle](#) to display photos in random order or [Standard](#) to display photos in continuous order ([Fig. 41](#)).

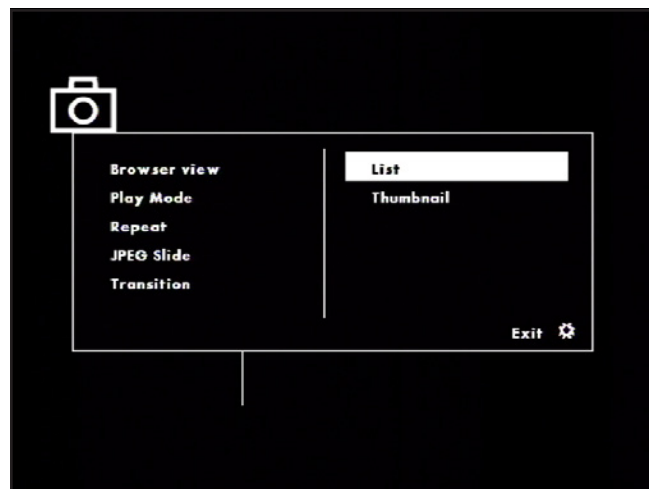

Fig. 40

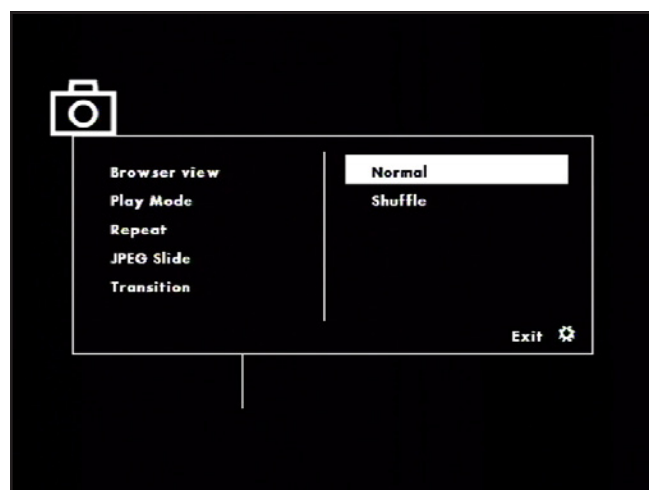

Fig. 41

4.3.3. Repeat

Set the repeat photo status. Select **ON** to repeat the photos in the folder continuously, and **Off** to stop playback at the end when all photos in the folder have been displayed (Fig. 42).

4.3.4. JPEG Duration

Sets the photo display duration. Choose from **Manual** (advances only with input from the remote control), **5s**, **10s**, and **15s** (Fig. 43).

4.3.5. Transition

Select the transition effect between two images. Choose from the available transitions, **Random** or **No Transition** (Fig. 44).

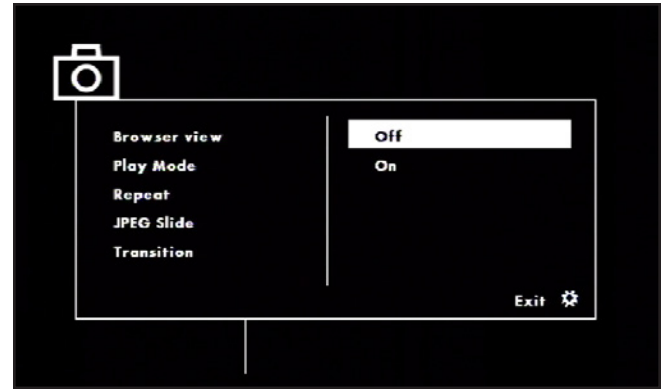

Fig. 42

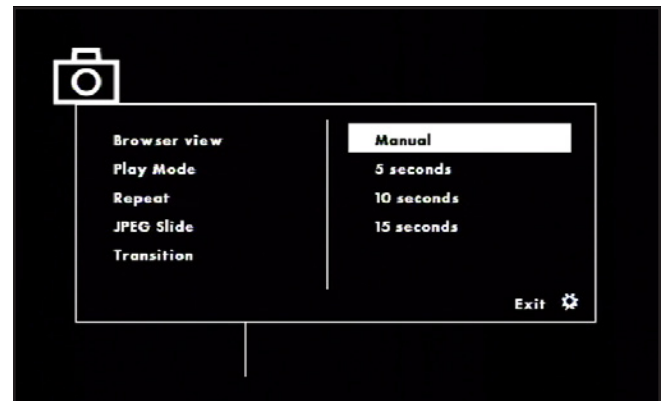

Fig. 43

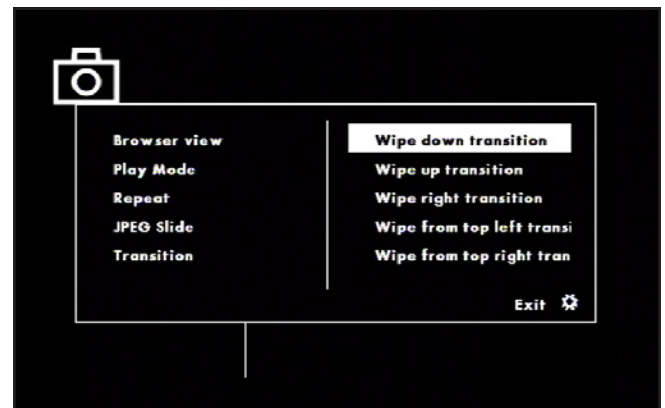

Fig. 44

4.4. File Browser Mode

You can scroll through the menu using the navigation buttons. To confirm your choice and enter a menu, press the **Play** button.

This menu will display all the multimedia files that you have uploaded to your LaCinema Classic Bridge.

You can scroll through the list of media files using the **Up** and **Down** buttons, **Right** button to open a folder and **Left** to move to upper folder level. To confirm your choice, press the **Play** button.

4.5. Playback from External Hard Drive

If you installed an internal hard drive, you can additionally connect a USB hard drive in order to play multimedia files located on the USB hard drive on your TV.

1. Plug in the power supply and connect your LaCinema Classic Bridge to your TV by following the instructions in section [3.3. Step 3: Connect to the TV](#).
2. Once the main menu is displayed on your television, connect a compatible USB disk to the USB expansion port on the front of the LaCinema Classic Bridge and wait a few seconds for the disk to be recognized.
3. With the remote control, select the media type you want to play. From the browsing menu, you will see the list of available storage volumes ([Fig. 45](#)).
4. Select the volume with a USB icon and press **Play** to navigate to the folder and select the movie (or song or photo) you want to play.

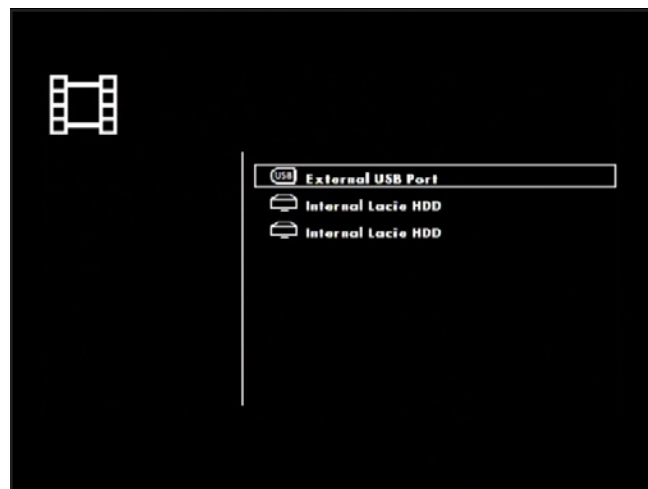

Fig. 45

4.6. Setup Menu

To modify settings, access the **Setup** menu by pressing the **Gear** button. Scroll through the **Setup** menu using the up and down buttons (*Fig. 46*).

To display the available options of a setup category, press the right button. To confirm your choice, press the play button. All changes are automatically saved.

Press the **Setup** button to display the main menu on the screen. When the setup menu is shown, the playback will be automatically paused.

Press the **Up** and **Down** buttons to select the desired setup, then press the **Play** button to confirm. Press the **Left** and **Right** buttons to select the submenu, then press **Play**.

To select another option, press the **Left** button to go back to an previous menu. Press the **Setup** button again to exit the setup menu from the screen.

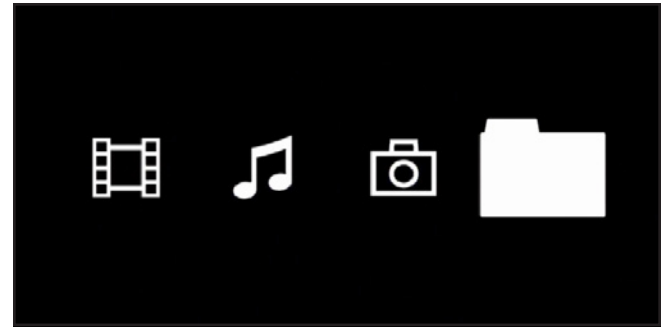

Fig. 46

4.6.1. Language

Language

Select the system language of the LaCinema Classic Bridge (*Fig. 47*).

DivX Subtitles

If your DivX files, includes a subtitle file, then you may select a supported DivX subtitle language by region.

TECHNICAL NOTE: If your DivX file does not include a subtitle file, you cannot use this selection. You will have to use external subtitle file with supported subtitle extension format: .srt, .sub, .txt, .smi, .ssa, .ass, .psb

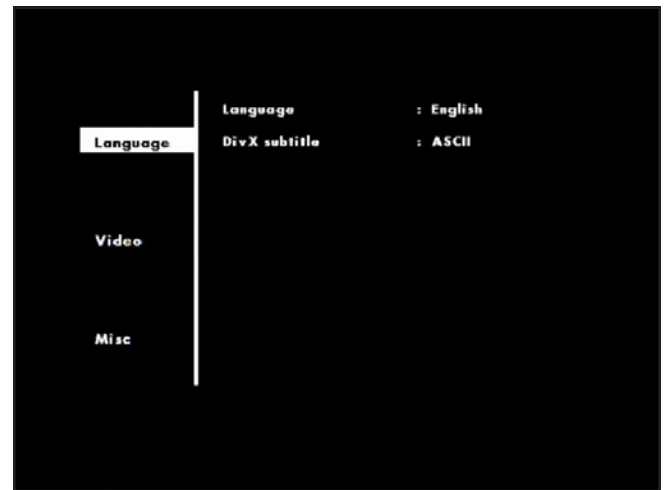

Fig. 47

4.6.2. Video

Aspect Ratio:

Choose between 16:9 (Default) and 4:3 (Fig. 48).

View Mode:

- ◆ Fill: Fill the screen with image.
- ◆ Original: Display image as its original size.
- ◆ Auto Fit (Default): Automatically fit the decoded image on screen without distortion.
- ◆ Pan Scan: Automatically display the decoded image on full screen without distortion

TV System:

- ◆ PAL
- ◆ NTSC

HD Resolution:

- ◆ Auto (default)
- ◆ 480p/576p
- ◆ 720p
- ◆ 1080i
- ◆ 1080p

HD Jpeg Mode:

- ◆ On / Off

Screen Saver:

- ◆ On / Off

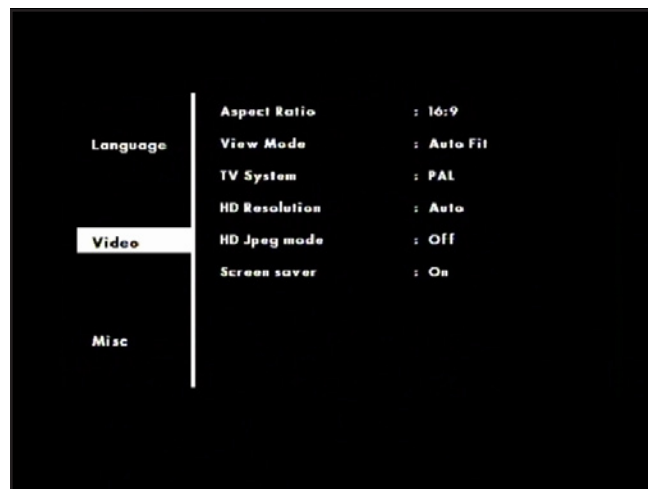

Fig. 48

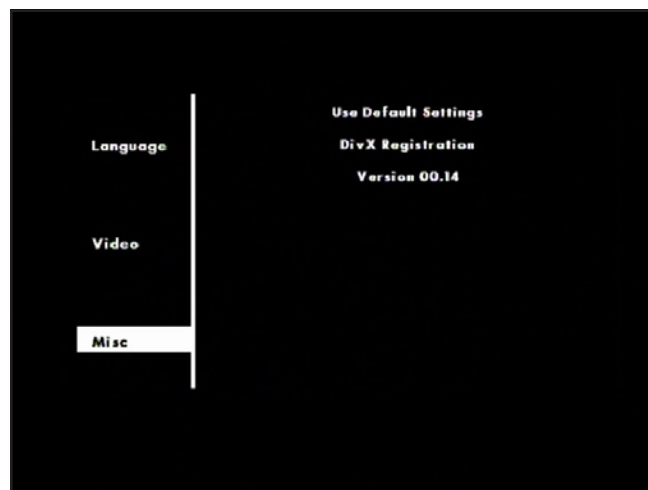

Fig. 49

4.6.3. Information

Default Settings

Use this function to reset the LaCinema Classic Bridge to its default parameters (Fig. 49).

DivX Registration

Displays the DivX registration information.

Firmware Version

Displays the current LaCinema firmware version.

4.7. Firmware Update

The LaCinema Classic Bridge allows you to update its firmware by loading downloaded firmware updates in the [Update](#) folder.

To update the firmware:

1. Go to www.lacie.com/support and click on the Downloads link.
2. Select the most recent LaCinema Classic Bridge firmware download. Connect your LaCinema Classic Bridge to your computer (Fig. 50). Drag the firmware file you just downloaded into the Update folder on the LaCinema Classic Bridge. Disconnect the LaCinema Classic Bridge from your computer and connect it to your TV.

IMPORTANT NOTE: If you connected a USB hard drive instead of installing and internal drive, you must create a folder called UPDATE (on the same level as the MOVIES, MUSIC, and PICTURES folders) and drag the firmware file into this folder.

3. Go to [Browser](#) view from the main menu.
4. Select the Update folder and press the [Play](#) button to open it.
5. Select [update.bin](#) file and press the [Play](#) button. The firmware update will begin after you confirmed the action. The update process will take approximately 2 minutes.
6. When the firmware update is completed, the product will restart automatically and show the main menu.

CAUTION: Never turn off the LaCinema Classic Bridge during the Firmware Update process! Doing so may damage your device. If, for any reason, the procedure fails (e.g. a power failure occurs during the update), you may not be able to use your LaCinema Classic Bridge. Please contact your reseller or LaCie Customer Support for more information.

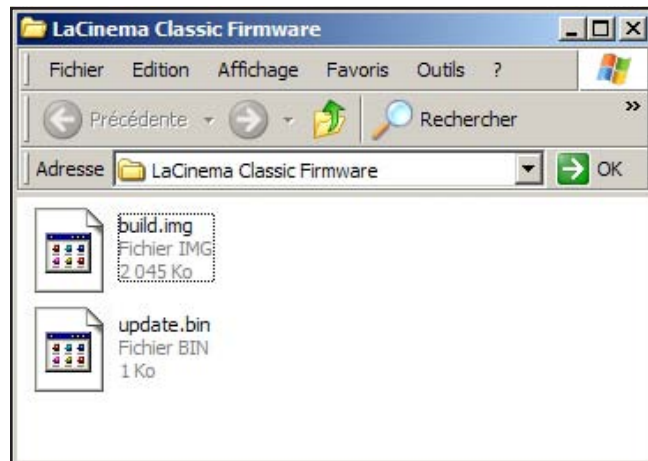

Fig. 50

5. Reformatting the LaCinema Classic Bridge

5.1. Windows Users

IMPORTANT INFO: The drive should not be reformatted to a file system other than FAT32 or FAT16. If the drive is formatted in a non-FAT32 format (such as NTFS or HFS+), files will NOT appear on your television screen. This format limitation is also valid for storage devices connect through the LaCinema Classic Bridge's USB expansion port on the front of the drive. For details, see [1.5. Views of the Drive](#).

The process of formatting a drive on a computer running Windows 2000, Windows XP or Windows Vista consists of two steps: (1) installing a signature on the drive, and (2) formatting the drive. These steps will erase anything that is on the disk.

CAUTION: Following these steps will erase everything from the LaCinema Classic Bridge. If you have information that you want to protect or continue to use, back up this information before performing these steps.

1. Connect the drive to the computer via the interface port.
2. Right-click [My Computer](#) and select [Manage](#).
3. From the "Computer Management" window, select [Disk Management](#) (located below the [Storage](#) group). See [Fig. 51](#).
4. If the "Initialize and Convert Disk Wizard" window appears, click [Cancel](#).
5. Windows will list the Hard Disks that are installed on the system. Locate the drive that is represented by the  icon. Right-click the icon and select [Initialize](#).
6. In the box to the right that says [Unallocated](#), right-click and select [New Partition...](#)
7. On the first page of the "New Partition Wizard," click [Next](#). See [Fig. 52](#).

[continued on next page >>](#)

NOTE: Alternatively, Windows users can use the Formatter Utility, located on the LaCie CD-ROM, to format the hard disk.

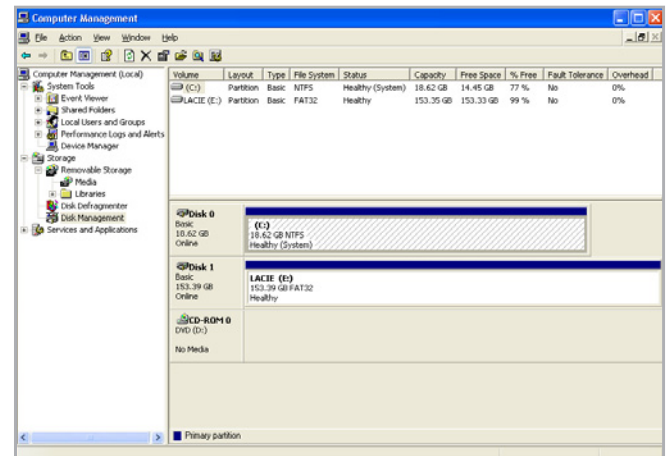

Fig. 51

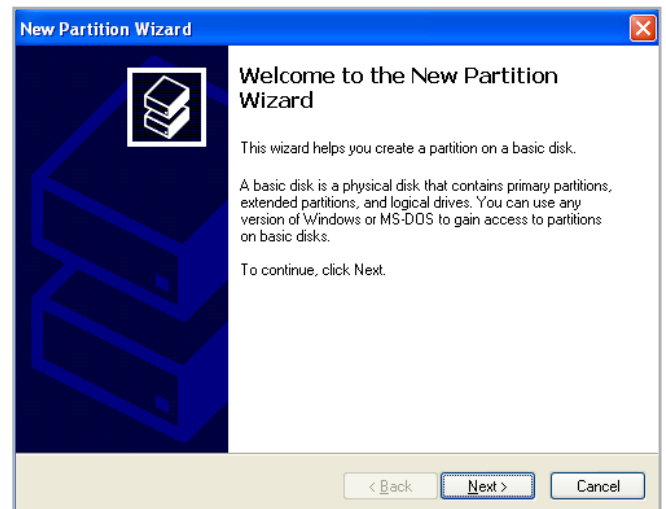

Fig. 52

8. Click [Next](#).
9. Click [Next](#).
10. Click [Next](#).
11. Click [Next](#).
12. On the Format Partition window, select [Quick Format](#). Click [Next](#) ([Fig. 53](#)).

IMPORTANT INFO: The drive should not be reformatted to a file system other than FAT 32. If the drive is formatted in a non-FAT32 format (such as NTFS or HFS+), files will NOT appear on your television screen.

13. Click [Finish](#) to begin the formatting process.
14. Windows Disk Management will format and partition the disk according to your settings ([Fig. 54](#)), and your drive will appear in [My Computer](#), ready to use.

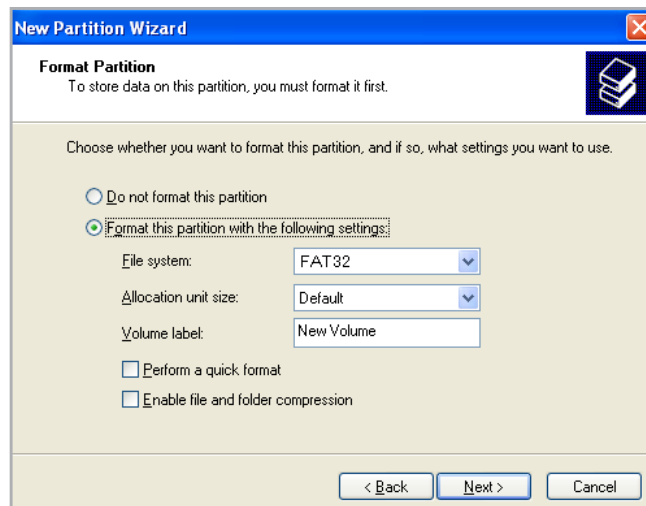

Fig. 53

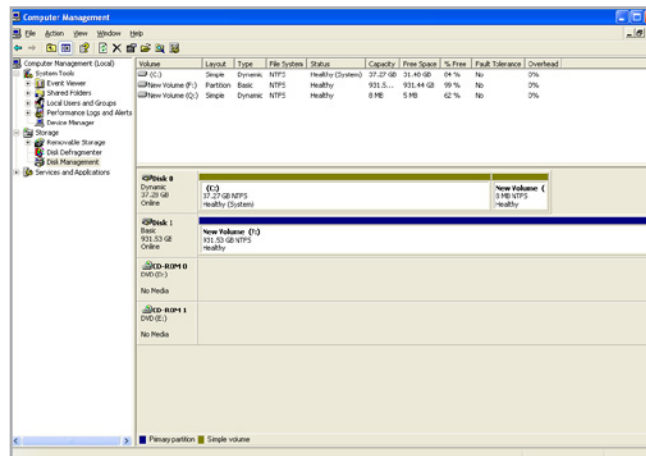

Fig. 54

5.2. Mac Users

CAUTION: Following these steps will erase everything from the LaCinema Classic Bridge. If you have information that you want to protect or continue to use, back up this information before performing these steps.

IMPORTANT INFO: The drive should not be reformatted to a file system other than FAT32 or FAT16. If the drive is formatted in a non-FAT32 format (such as NTFS or HFS+), files will NOT appear on your television screen. This format limitation is also valid for storage devices connect through the LaCinema Classic Bridge's USB expansion port on the front of the drive. For details, see [1.5. Views of the Drive](#).

1. Connect the drive to the computer and turn on the drive.
2. Select [Utilities](#) from the [Go](#) menu in the Finder menu bar.
3. In the Utilities folder, double-click [Disk Utility](#).
4. The Disk Utility window will open. Select the volume labeled [LaCie Hard Disk](#) from the list of available hard disks on the left side of the window.
5. Select the [Erase](#) tab.
6. Give the drive a name and click **Erase**.
7. The drive is now ready for use with your LaCinema Classic Bridge.

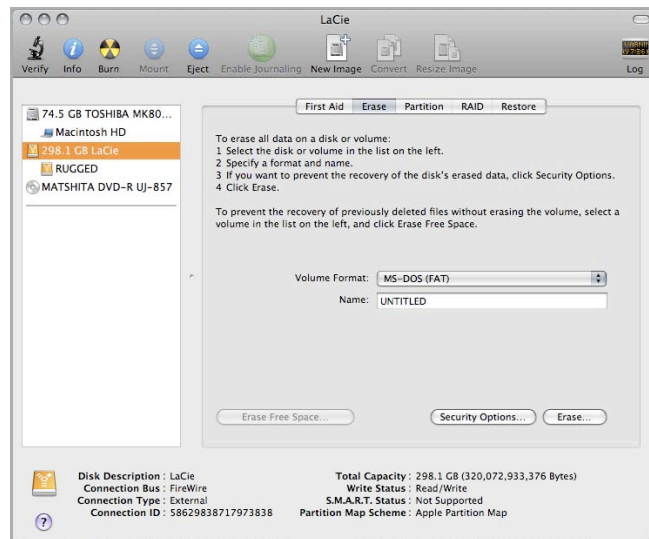

Fig. 55

6. Technical Information

6.1. XviD Compatibility

The LaCinema Classic Bridge is fully compatible with the XviD format (an ISO, MPEG-4 compliant video codec), and can play any video encoded with this compression format.

6.2. Optimizing Data Transfers

Data transfers are the flow of data that accomplishes a task, usually related to moving data from storage to computer RAM, or between storage devices. With external drives, such as the LaCinema Classic Bridge, the data is transferred from the drive to the computer via the USB interface. The data is fed from the drive through the USB port on the drive, and passes to the computer through the USB host-bus adapter interface.

USB

To utilize the enhanced Hi-Speed USB 2.0 performance, your computer must be equipped with a Hi-Speed USB 2.0 host bus adapter card (either sold separately, or integrated by your computer's manufacturer) and the appropriate drivers. These host bus adapter cards, which include one or more USB ports, are shipped with special Hi-Speed USB 2.0 drivers that enable the computer to control the card. These drivers must be installed in order for USB 2.0 devices connected to the port to work at their correct speeds.

Computers running Windows XP and Windows Vista automatically manage Hi-Speed USB 2.0 devices and drivers, while Windows 98 SE and Windows Me will require that drivers be installed before a Hi-Speed USB 2.0 device is attached.

Mac OS 9.x does not support Hi-Speed USB 2.0 functionality, and all Hi-Speed USB 2.0 devices will only operate at the original USB specifications. Mac OS 10.2.7 and later supports Hi-Speed USB 2.0, and Mac OS 10.x also supports Hi-Speed USB 2.0, but you will have to purchase a third-party PCI or PC Card and appropriate drivers.

Contact your LaCie reseller or LaCie Customer Support for information about Hi-Speed USB 2.0 PCI or PC Cards, or visit our Web site: www.lacie.com.

7. Troubleshooting

If your LaCinema Classic Bridge is not working correctly, please refer to the following checklist to determine the source of the problem. If you have gone through all of the points on the checklist and your LaCinema Classic Bridge still does not work properly, please check the FAQs that are regularly published on our website – www.lacie.com. One of these FAQs may provide an answer to your specific question. You can also visit the downloads page, where the most recent software updates will be available.

If you need further assistance, please contact your LaCie reseller or LaCie Customer Support (see section 8. [Contacting Customer Support](#) for details).

Manual Updates

LaCie strives to give you the most up-to-date, comprehensive user manuals available on the market. It is our goal to provide you with a friendly, easy-to-use format that will help you quickly install and utilize the many functions of your new device.

If your user manual does not reflect the configuration of the product you purchased, please check our website for the most current version of the user manual.

www.lacie.com

7.1. Troubleshooting: Mac Users

Problem	Question	Answer
The drive is not recognized by the computer.	Does an icon for the drive appear on the desktop?	There should be an icon for the LaCie drive on the desktop. If the drive does not appear, follow the rest of the Troubleshooting tips to isolate the problem.
	Does your computer's configuration meet the minimum system requirements for use with this drive?	See section 1.1. Minimum System Requirements for more information.
	Is the drive's power supply connected and turned on?	Make sure that the power supply is properly connected, that the drive has been turned on and that the outlet the power supply is connected to is working.
	Did you follow the correct installation steps for the specific interface and operating system?	Review the installation steps in section 3. Setting Up the LaCinema Classic Bridge .

Problem	Question	Answer
The drive is not recognized by the computer.	Are both ends of the USB cable securely attached?	Only use a USB cable provided by LaCie. Check both ends of the USB cable to make sure they are fully seated in their respective ports. Try disconnecting the cables, waiting 10 seconds, and then reconnecting them. If the drive is still not recognized, restart your computer and try again.
	Is there a conflict with other device drivers or extensions?	Contact LaCie Technical Support for help.
	Does your computer's operating system support the file system?	Check your computer's documentation and see section 5. Reformatting the LaCinema Classic Bridge for more information.
	Did you correctly install the internal hard disk?	If you installed an internal hard disk, make sure that its SATA connector is firmly connected to the port inside the LaCinema Classic Bridge. Also check the procedure in section 3.1.2. Option B: Install an Internal Hard Drive .
Error messages under Mac OS 10.x.	Did you get an "Error -50" message while copying to a FAT 32 (MSDOS) volume?	When copying files or folders from Mac OS 10.x to a FAT 32 volume, file names with certain characters cannot be copied. These characters include, but are not limited to: ? < > / \ : Check your files and folders to ensure that these types of characters are not being used.
The drive is not running noticeably faster when connected via Hi-Speed USB 2.0.	Are you operating in Mac OS 9.x?	Apple does not support the Hi-Speed USB 2.0 standard under Mac OS 9.x. You will be limited to the slower transfer rates of the original USB standard. For more information, please see section 6.2. Optimizing Data Transfers .
	Is the drive connected to a standard USB port on your computer?	If your drive is connected to a standard USB port, this is normal. A Hi-Speed USB 2.0 device can only operate at Hi-Speed USB 2.0 performance levels when it is connected directly to a Hi-Speed USB 2.0 port. Otherwise, the Hi-Speed USB 2.0 device will operate at the slower USB transfer rates. For more information, please see sections 6.2. Optimizing Data Transfers and 1.6. Cables and Connectors .
	Is the drive connected to a Hi-Speed USB 2.0 port on your computer?	Check to see that the Hi-Speed USB 2.0 drivers for both your host bus adapter and device have been installed correctly. If in doubt, un-install the drivers and re-install them. Also, make sure that you are connected directly to a Hi-Speed USB 2.0 port on your computer.
	Does your computer or operating system support Hi-Speed USB 2.0?	See sections 1.1. Minimum System Requirements and 6.2. Optimizing Data Transfers for more information.

7.2. Troubleshooting: Windows Users

Problem	Question	Answer
The drive is not recognized by the computer.	Has the drive been formatted?	Make sure that the drive has been formatted properly. Please see section 5. Reformatting the LaCinema Classic Bridge .
	Does your computer's operating system support the file system?	Check your computer's documentation and see section 6. Reformatting the LaCinema Classic Bridge.
	Is there an icon for the drive in My Computer?	Go into My Computer and look for an icon and drive letter assigned to the LaCie drive. If the drive does not appear, follow the rest of the Troubleshooting tips to isolate the problem. Go into My Computer and look for an icon and drive letter assigned to the LaCie drive. If the drive does not appear, follow the rest of the Troubleshooting tips to isolate the problem.
	Does your computer's configuration meet the minimum system requirements for use with this drive?	See section 1.1. Minimum System Requirements for more information.
	Is the drive's power supply connected and turned on?	Make sure that the power supply is properly connected, that the drive has been turned on and that the outlet the power supply is connected to is working.
	Did you follow the correct installation steps for the specific interface and operating system?	Review the installation steps in section 3. Setting Up the LaCinema Classic Bridge .
	Are both ends of the USB cables firmly attached?	Check both ends of the USB cable to make sure they are fully seated in their respective ports. Try disconnecting the cables, waiting 10 seconds, and then reconnecting them. If the drive is still not recognized, restart your computer and try again.
	Is there a conflict with other device drivers or extensions?	Contact LaCie Technical Support for help.
	Did you correctly install the internal hard disk?	If you installed a internal hard disk, make sure that its SATA connector is firmly connected to the port inside the LaCinema Classic Bridge. Also check the produce in section 3.1.2. Option B: Install an Internal Hard Drive .

Problem	Question	Answer
The drive is not running noticeably faster when connected via Hi-Speed USB 2.0.	Is the drive connected to a standard USB port on your computer?	If your drive is connected to a standard USB port, this is normal. A Hi-Speed USB 2.0 device can only operate at Hi-Speed USB 2.0 performance levels when it is connected directly to a Hi-Speed USB 2.0 port. Otherwise, the Hi-Speed USB 2.0 device will operate at the slower USB transfer rates. For more information, please see sections 6.2. Optimizing Data Transfers and 1.6. Cables and Connectors .
	Is the drive connected to a Hi-Speed USB 2.0 port on your computer?	Check to see that the Hi-Speed USB 2.0 drivers for both your host bus adapter and device have been installed correctly. If in doubt, un-install the drivers and re-install them. Also, make sure that you are connected directly to a Hi-Speed USB 2.0 port on your computer.
	Does your computer or operating system support Hi-Speed USB 2.0?	See sections 1.1. Minimum System Requirements and 6.2. Optimizing Data Transfers for more information.

7.3. Troubleshooting: TV/Stereo Connection

Problem	Question	Answer
Checking the firmware version.	How do you know which firmware version your LaCinema Classic Bridge is using?	To check which firmware is currently installed on your LaCinema Classic Bridge, attach it to your TV and use the remote control to navigate to the Settings > Information menu. The firmware version is displayed in the upper right corner of this screen.
	How do you get new firmware, and how do you install it?	For a detailed explanation, please see section 4.7. Firmware Update or go to www.lacie.com .
DivX® and XviD® compatibility.	When a new version of DivX® or XviD® is released, will the LaCinema Classic Bridge be able to play those files, too?	Provided that the new version complies with the ISO MPEG-4 standard, the LaCinema Classic Bridge should be able to play the new versions.
	Does the LaCinema Classic Bridge support external subtitles with DivX® files?	Yes, the LaCinema Classic Bridge does support this functionality by using Unicode text files with extensions .sub (MicroDVD format) and .smi. In order to work correctly, use the same file name for both the video file and subtitle text file, and store both of them in the same folder location on your LaCinema Classic Bridge. For example, if the file name of the video file is "Movie.avi," then you will need to re-name the subtitle text as either "Movie.sub" or "Movie.srt."
There is no picture being displayed.	Are all of the cables connected correctly?	Ensure that all of the cables are connected correctly. If you are using the Composite A/V cable, make sure that the component cable is not plugged in at the same time. See section 3.3. Step 3: Connect to the TV .
Optimizing video connections.	What connectivity method will produce the best quality?	For optimal quality and performance, the best video connection is the HDMI cable (included).

Viewing photos.	Does it take several seconds to load a picture?	Depending on file size, photos may take several seconds to load properly. Reducing the photo's resolution will reduce the file size, as well, and allow the file to load faster.
"Empty Folder" message appears.	Are there compatible files in the appropriate folder?	If you know that there are compatible files in the folder and they are not being displayed, move the power switch on the back of the LaCinema Classic Bridge to the OFF position, wait several seconds, and then turn the LaCinema Classic Bridge on. Your files should now be displayed.

8. Contacting Customer Support

Before You Contact Technical Support

1. Read the manuals.
2. Try to isolate the problem. If possible, make the drive the only external device on the CPU, and make sure that all of the cables are correctly and firmly attached.

If you have asked yourself all of the pertinent questions in the troubleshooting checklist, and you still can't get your LaCie drive to work properly, contact us at www.lacie.com. Before contacting us, make sure that you are in front of your computer and that you have the following information on hand:

Information	Where to Find Information
1. LaCie hard drive serial number	Located on a sticker at the back of drive or on the original packaging
3. Macintosh/PC model	<p>Mac users: Click on the Apple icon in the menu bar and select About This Mac.</p> <p>Windows users: Right click My Computer and select Properties > General.</p>
4. Operating system version	
5. Processor speed	
6. Computer memory	<p>Mac users: Click on the Apple icon in the finder bar and select About This Mac. Select More Info... The Apple System Profiler will launch and will list your internal and external peripherals.</p> <p>Windows users: Right click My Computer and select Properties > Hardware.</p>
7. The brands and models of other internal and external peripherals installed on your computer	

8.1. LaCie Technical Support Contacts

LaCie Asia, Singapore, and Hong Kong Contact us at: http://www.lacie.com/asia/contact/	LaCie Australia Contact us at: http://www.lacie.com/au/contact/
LaCie Belgium Contact us at: http://www.lacie.com/be/contact/ (Français)	LaCie Canada Contact us at: http://www.lacie.com/caen/contact/ (English)
LaCie Denmark Contact us at: http://www.lacie.com/dk/contact	LaCie Finland Contact us at: http://www.lacie.com/fi/contact/
LaCie France Contact us at: http://www.lacie.com/fr/contact/	LaCie Germany Contact us at: http://www.lacie.com/de/contact/
LaCie Italy Contact us at: http://www.lacie.com/it/contact/	LaCie Japan Contact us at: http://www.lacie.com/jp/contact/
LaCie Netherlands Contact us at: http://www.lacie.com/nl/contact/	LaCie Norway Contact us at: http://www.lacie.com/no/contact/
LaCie Spain Contact us at: http://www.lacie.com/es/contact/	LaCie Sweden Contact us at: http://www.lacie.com/se/contact
LaCie Switzerland Contact us at: http://www.lacie.com/chfr/contact/ (Français)	LaCie United Kingdom Contact us at: http://www.lacie.com/uk/contact
LaCie Ireland Contact us at: http://www.lacie.com/ie/contact/	LaCie USA Contact us at: http://www.lacie.com/contact/
LaCie International Contact us at: http://www.lacie.com/intl/contact/	

9. Warranty Information

LaCie warrants your drive against any defect in material and workmanship, under normal use, for the period designated on your warranty certificate. In the event this product is found to be defective within the warranty period, LaCie will, at its option, repair or replace the defective drive.

This warranty is void if:

- ◆ The drive was operated/stored in abnormal use or maintenance conditions;
- ◆ The drive is repaired, modified or altered, unless such repair, modification or alteration is expressly authorized in writing by LaCie;
- ◆ The drive was subjected to abuse, neglect, lightning strike, electrical fault, improper packaging or accident;
- ◆ The drive was installed improperly;
- ◆ The serial number of the drive is defaced or missing;
- ◆ The broken part is a replacement part such as a pickup tray, etc.
- ◆ The tamper seal on the drive casing is broken.

LaCie and its suppliers accept no liability for any loss of data during the use of this device, or for any of the problems caused as a result.

LaCie will not, under any circumstances, be liable for direct, special or consequential damages such as, but not limited to, damage or loss of property or equipment, loss of profits or revenues, cost of replacement goods, or expense or inconvenience caused by service interruptions.

Any loss, corruption or destruction of data while using a LaCie drive is the sole responsibility of the user, and under no circumstances will LaCie be held liable for the recovery or restoration of this data.

Under no circumstances will any person be entitled to any sum greater than the purchase price paid for the drive.

To obtain warranty service, call LaCie Technical Support. You will be asked to provide your LaCie product's serial number, and you may be asked to furnish proof of purchase to confirm that the drive is still under warranty.

All drives returned to LaCie must be securely packaged in their original box and shipped with postage prepaid.

IMPORTANT INFO: Register online for free technical support:
www.lacie.com/register

10. Glossary

480p – Also known as 480 progressive, this is a form of standard-definition digital television (SDTV) which is similar to VGA computer displays. A DVD's resolution is 480p, but this resolution can only be seen when the DVD player outputs a progressive-scan signal, and the television has progressive-scan or component-video inputs.

720p – Also known as 720 progressive, this is one of two formats designated as a high-definition digital television (HDTV), ATSC DTV standard. This technology uses progressive scanning and is comprised of 720 vertical pixels by 1,280 horizontal pixels.

1080i – Also known as 1080 interlaced, this is the second of two formats designated as a high-definition digital television (HDTV), ATSC DTV standard. This technology uses interlaced scanning and is comprised of 1,080 vertical pixels by 1,920 horizontal pixels.

AVI (Audio Video Interleave) – A file format that can contain audio/video compressed standards using different combinations of codecs (e.g. DivX® video file and a WMA audio file). **DivX®** – A video codec developed from the new MPEG-4 compression standard, which allows for compression/decompression of videos into a specified format. The DivX® codec can play movies using any DivX®-enabled player, such as the LaCinema Classic Bridge. DivX® movies offer better compression and higher quality than standard MPEG movies.

Dolby Digital – Dolby Digital lets you experience 5.1-channel surround sound while supporting monaural (single channel) and stereo (two-channel) setups. In a 5.1-channel environment, there are five discrete full-range channels—Left, Center, Right, Left Surround, and Right Surround—plus a sixth channel for low-frequency effects.

DTS – Digital sound technology, which provides the technology for virtually all movie soundtracks.

Firmware – Permanent or semi-permanent instructions and data programmed directly into the circuitry of a programmable read-only memory or an electronically-erasable, programmable read-only memory chip. Used for controlling the operation of the computer or tape drive. Distinct from the software, which is stored in random access memory and can be altered.

ID3 Tag – An embedded tag in MP3 files that communicates a song's title, artist and album. These tags can be edited.

MPEG (Motion Picture Experts Group) – These are the developers of the MPEG-1 (VideoCDs), MPEG-2 (DVDs and SuperVCDs) and MPEG-4 (DivX®, WMV) video compression standards. The MPEG group is also responsible for the development of the MP3 and AAC audio compression standards.

NTSC (National Television Standards Committee) – This group is responsible for the development of a set of protocols used for transmission and reception of TV broadcasts in the United States. An NTSC image has 525 horizontal lines per frame, which are interlaced from left to right, top to bottom. NTSC signals are not directly compatible with computer systems.

PAL (Phase Alternation Line) – This is the analog TV display commonly used in Europe. The PAL image has 625 horizontal lines per frame, and the color definition differs slightly from the NTSC standard.

VOB (Video Objects) – The format in which DVD movies are stored. Within each VOB file, a number of video/audio/subpicture streams are stored. Subpicture streams refer to the subtitles on DVDs and other VOB files. These subtitles are video streams that overlay the main picture stream, and can be turned on or off.

WMA (Windows Media Audio) – An audio format developed by Microsoft® for audio streaming and compression.

XviD – A video codec, very similar to DivX®, based on the MPEG-4 compression standard. This an open-source video codec that is currently being developed around the world. The XviD codec can play movies using any XviD-enabled player, such as the LaCinema Classic Bridge.